

Product PASSIVE PFC	Size EI42-20	Type OPEN
-------------------------------	------------------------	---------------------

Product designation

PASSIVE PFC CHOKES - EI42x20 - OPEN

I MECHANICAL CHARACTERISTICS - PINOUT

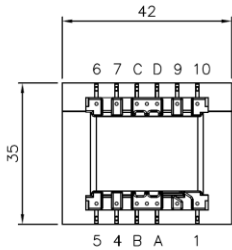
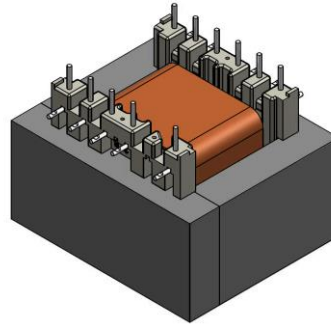
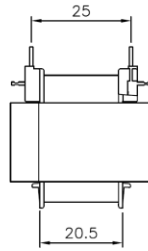
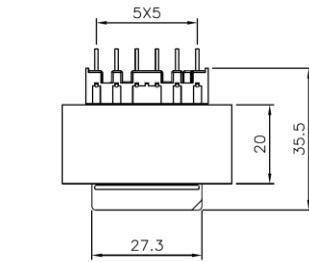

Terminals	
Pins	Ø 0.80 +/- 0.10 mm
PCB recommended drilling diameter	1.3 mm
Pins length	4.0 +/- 0.5 mm
Missing pin	position 2
Tolerances	
General tolerance	+/- 0.5 mm
Pins pitch tolerance	+/- 0.5 mm
Pins row tolerance	+/- 0.5 mm

II ELECTRICAL CHARACTERISTICS - ENVIRONMENTAL

Typical use at ambient 50, 60 or 70 °C

Reference	Inductance (mH)	Rated current (A _{RMS})	Sat. current (A _{pk})	Temperature class	Type
43350	1.0	5.9	14.0	T70 / F	1
43351	1.5	5.8	13.3	T70 / F	1
43352	2.0	5.2	11.4	T70 / F	1
43353	2.5	4.5	9.4	T70 / F	1
43354	3.0	4.4	8.8	T60 / F	2
43355	3.5	4.4	8.4	T50 / F	2
43356	4.0	4.4	7.8	T50 / F	2
43357	4.5	4.0	7.2	T50 / F	2
43358	5.0	3.9	7.0	T50 / F	2
43359	10.0	2.9	5.2	T50 / F	1
43360	15.0	2.4	4.3	T50 / F	2
43361	20.0	2.0	3.5	T50 / F	2

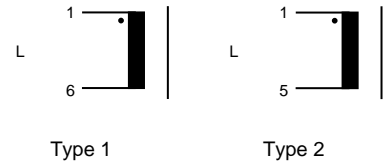

Operating temperature - 40 / + 140 °C
Storage temperature - 40 / + 85 °C

Rated currents (A_{RMS}) will give temperature rising of 60 K for T70, 70 K for T60 and 80 K for T50.

Saturation currents (A_{pk}) are stated for a maximum inductance drop of 20%

III SAFETY - APPROVAL

RoHS and REACH compliant

UL94 V-0 materials

Construction conforms to the certified MYRRA Class F UL Electrical Insulation System E113497-F5.

Compliant with IEC61558-2-20