



Power Supplies

Encapsulated Solutions

1W ~ 60W



LED Driver Solutions

IP65 + 3 In 1 dimming

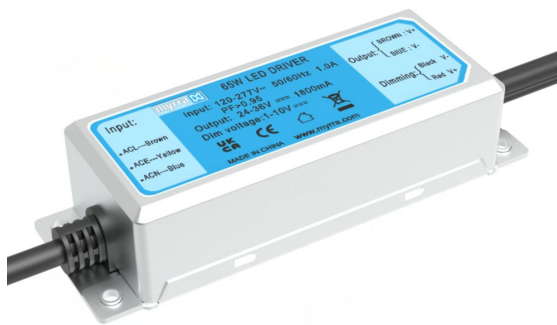

Industrial Power Supplies

60W ~ 100W



www.myrra.com

www.myrra-powersupplies.com

Myrra company Profile

Myrra Transformers, Inductors, Chokes and Power Supplies are World renowned for their reliability and performance.

This is the result of constant technological development and continuous production process improvements, which has made Myrra Group a leading Company in both design (R&D) and manufacturing.

With their own range of products, including encapsulated Power Supplies, Transformers (50/60Hz), HF Transformers and Value-Added Services, Myrra has become a reliable and renowned Global Supplier.

Since incorporation in 1949, Myrra has become one of the largest European sources for their products in the electrical market, and is striving to grow their position in a continuously evolving market.

As a Company certified by VDE, UL, CSA, ISO9001 and with a clear policy for conservation of the environment (RoHs, REACH, ISO14001), Myrra is an ideal partner for your future requirements.

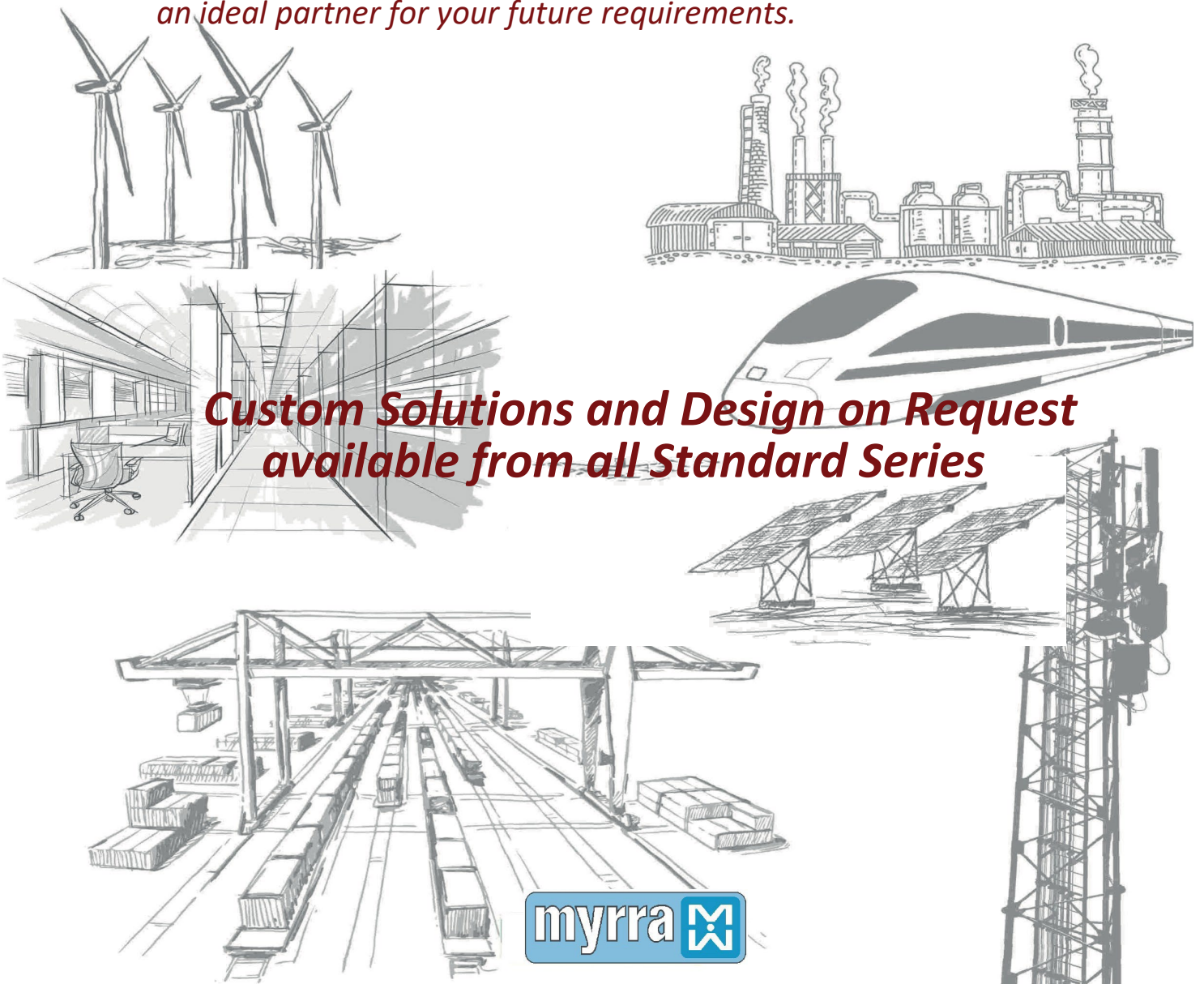

**Custom Solutions and Design on Request
available from all Standard Series**

myrra

Encapsulated Power Supplies

"We at Myrra, Design and Manufacture all our Power Products, ensuring our Customers experience consistent Quality and Reliability"

Catalogue Contents

Page	Details
2-3	Products overview
48000 Series	
4	Single Output 1W ~3W
47000 Series & 49000 Series	
6	Single Output 2.0W ~ 5W (49XXXC)
8	Single Output 2.5W ~ 5W
10	Single Output 2.4W ~ 5W (relaxed regulation)
12	Dual Output 3W ~ 5W (common ground)
14	Dual Output 3W ~ 4W (isolated outputs)
16	Single Output 7.5W
18	Single Output 5W ~ 10W (49XXXE)
20	Single Output 10W
22	Single Output 20W (49XXYG)
24	Single Output 20W (47000)
26	Single Output 50W ~ 60W
LED Driver Solutions	
28	LED Driver 48W ~ 65W
Industrial Power Supplies	
30	Single Output 60W ~ 100W
Support and Service	
32	Application notes 47000,48000 and 49000 series
33	Modified and Custom Solutions

Note:



- Indicates that this family is recommended for new design in projects



Power Supplies

1 W to 3 W

3 Certified Power Ratings

In
1 Power Supply

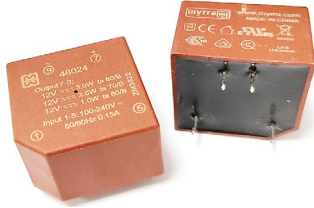

2W to 5W

3 Certified Power Ratings

In
1 Power Supply



5W to 10W

3 Certified Power Ratings

In
1 Power Supply

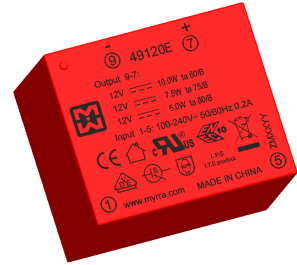

2.5W to 5W



20W to 60W



LED Driver

48W to 65W

IP65 Rating, 3 In 1 Dimming
Built-in Active PFC Function



Industrial Power Supplies

60W to 100W

Built-in Active PFC Function



POWER SUPPLIES 1W to 60W

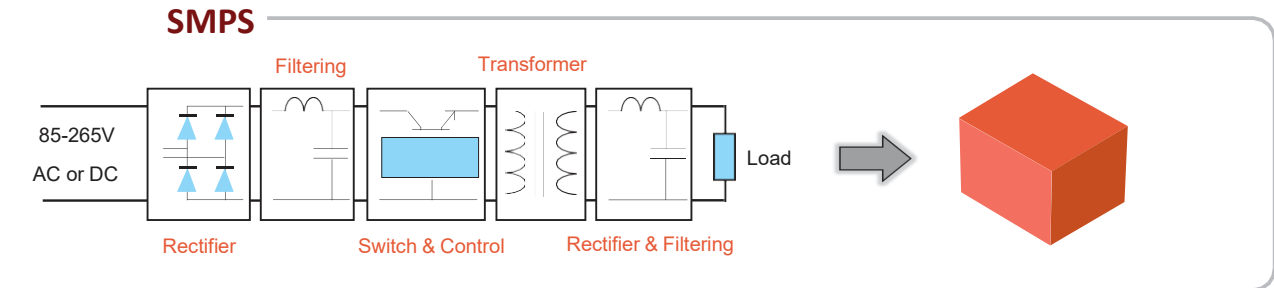
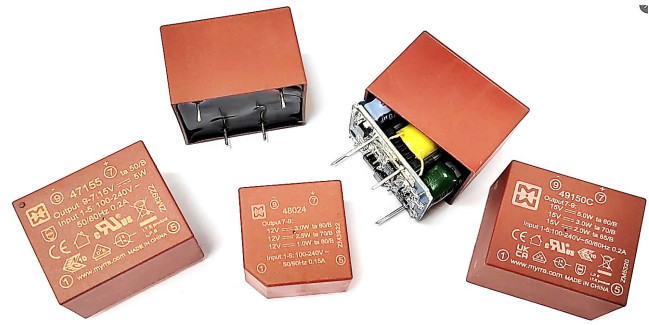

MYRRA encapsulated Switched Mode Power Supplies is based on Flyback topology.

They constitute an interesting alternative to the traditional supply in the most common applications of power from 1W to 60W.

ENERGY SAVING due to high efficiency and low standby power.

Application for our Power Supplies:

- Alternative to the linear transformers in all AC/DC applications of power up to 60W
- Alternative to DC/DC converters for application in D.C. current (Telecom supplies, electric substations etc.)
- Industrial, domestic and consumer electronics applications
- Standby devices and others DC or AC auxiliary supplies

With the same footprint as an EI30 transformer, they will replace:

- 50 Hz Transformer
- Fuse
- Bridge Rectifier
- Filtering Capacitor

Regulated types will also replace linear regulator and heatsink

MAIN FEATURES

- Wide input voltage range
- Increased power: 3 x compared to standard EE20-EI30-EI38 transformers
- Better energetic efficiency: 70% typical compared to 40% for the conventional supply
- Very low Standby Power consumption: meets requirements of Energy Star or EC Code of Conduct
- Same footprint as EE20-EI30-EI38-EI48 transformer: (1W~10W)
Upgrade your application without redesign of PCB

SAFETY STANDARDS

Meets all requirements of:

- IEC/EN62368-1
- IEC/EN60950-1
- IEC/EN60335-1
- IEC/EN61558-2-16
- IEC/EN61558-1
- UL62368-1
- CSA 22.2 N°62368-1
- UL60950-1
- CSA 22.2 N°60950-1-
- UL 94-V0

EMC STANDARDS

Conducted and radiated emissions conform to

- EN 55014-1
- EN 55032 class B

Immunity conform to

- EN 55014-2
- EN 61000-4-x

ONE OUTPUT 1W to 3W - Small Compact Size



MAIN FEATURES

- Small Compact Size - PCB Mount
- Single Output
- Output Range: 3.3VDC - 24VDC
- Input Range: 85VAC - 265VAC/47 - 63Hz Or 120VDC - 370VDC
- Very Low Standby Power Consumption < 0.15W
- Better Energetic Efficiency : Meet Requirements Of Energy Star And EC Code Of Conduct
- Encapsulated Design And Same Footprint As EE20 Transformer : Upgrade Your Application Without Redesign Of PCB
- Safety: IEC/EN61558-2-16, IEC/EN60950-1, IEC/EN60335-1, IEC/EN62368-1, UL62368-1, UL60950-1, CAN/CSA22.2No.60950-1-07 CSA22.2No.62368-1-14
- Materials : Uses UL 94-V0 Plastic And Resin
- EMC : Conducted And Radiated Emissions Conform To EN55014, EN55032, FCC Part 15, CLASS B without any additional components.
- Immunity Conform To: IEC/EN61000-3-2 CLASS A, EN61000-3-3, EN61000-4-2, IEC/EN61000-4-3, EN61000-4-4, EN61000-4-5, EN61000-4-6, EN61000-4-8, EN61000-4-11

Part Number	Output Power (W)	Output Voltage (Vdc)	Output Current (mA)	Output Load Regulation (%)	Max. Operating Ambient (°C)	Min. Part Efficiency(%)
48021	1	3.3	300	± 6	80	60
	2.5		750		60	63
	2.75		830		50	63
48022	1	5	200	± 5	80	60
	2.5		500		60	65
	3		600		50	65
48023	1	9	110	± 5	80	67
	2.5		280		70	70
	3		330		60	70
48024	1	12	84	± 5	80	67
	2.5		210		70	72
	3		250		60	72
48025	1	15	67	± 5	80	67
	2.5		170		70	72
	3		200		60	72
48026	1	18	56	± 5	80	67
	2.5		140		70	72
	3		170		60	72
48027	1	24	42	± 5	80	70
	2.5		105		70	74
	3		125		60	74

DIMENSIONS and PINOUT

4 pins

PRI : Pins 1 - 5 : AC or DC Input

SEC : Pin 7 : DC Output +V

Pin 9 : DC Output OV

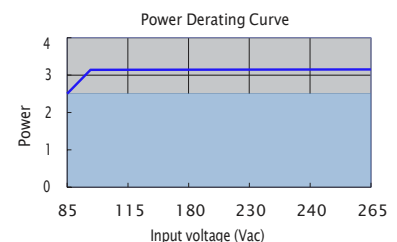
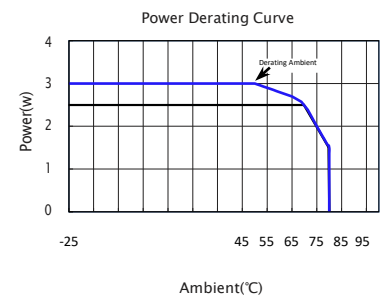
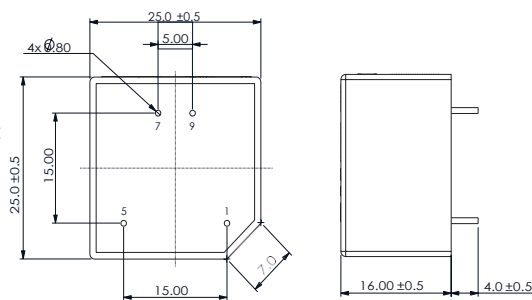

Model: 1 to 3 Watt		Specification
AC Input Characteristics	Rated AC input Voltage	100~240Vac or 140VDC-340VDC
	AC Input Voltage Range	85~265Vac or 120VDC-370VDC
	AC Input Frequency Range	47Hz~63Hz
	Rated AC Input Frequency	50/60Hz
	Input Current	0.15A Max@85Vac~265Vac, at full load
	Standby Power	0.15W Max(Meet Requirements Of Energy Star And EC Code Of Conduct)
DC Output Characteristics	Output Voltage Accuracy	3.3V type: $\pm 6\%$ Other types(5V,9V,12V,15V,18V and 24V): $\pm 5\%$
	Output Voltage Line Regulation	3.3V type: $\pm 5\%$ Other types(5V,9V,12V,15V,18V and 24V): $\pm 3\%$
	Output Voltage Load Regulation	3.3V type: $\pm 6\%$ Other types(5V,9V,12V,15V,18V and 24V): $\pm 5\%$
	Ripple & Noise	Max 200mVp-p@ Rated AC input, at nominal line (The measuring will be terminated with a 47uF AL E-Cap and a 0.1uF Ceramic-Cap. An oscilloscope set at 20MHz bandwidth)
	Dynamic Response	The output voltage shall not exceed $\pm 10\%$ rated output voltage @ 50% \leftrightarrow 100% Load change, 1A/uS, 1KHz 50% duty cycle
	Hold Up Time	5mS min@ 100Vac ~240Vac, DC output with full load
	Turn On Delay	35 max @ 85Vac~265Vac input and DC output with full load
	Rise Time	50ms max @ 85Vac~265Vac input and DC output with full load
	Overshoot	The output voltage shall not exceed +10% rated output voltage @ Power on and 85Vac~265Vac input, and DC with full load
	Undershoot	The output voltage shall not exceed -10% rated output voltage @ Power off and 85Vac~265Vac input and DC output with full load
	Efficiency	See table (Meets Requirements Of Energy Star And EC Code Of Conduct)
Protection Characteristics	Over Current Protection	The power supply shall automatic protect. The power supply shall auto-recover normal operation after the deformation is removed. No excessive heat, odor, or plastic deformation shall occur with no safety hazard
	Output Short Circuit Protection	The power supply shall withstand a continuous output short without damage in 24 hours; The short may be applied before power on, or after power on; The power supply shall resume normal operation after the short is removed, no excessive heat, odor, or plastic deformation shall occur with no safety hazard
	Over temperature protection	The power supply shall shut down when the junction temperature of PWM controller exceeds the thermal shutdown temperature, typically 140°C $\pm 10^\circ\text{C}$
Environmental	Operation Temperature	-25°C ~+ (see table)
	Operation Humidity	10~ 90% RH(No Condensing) @ DC output with full load
	Storage Temperature	-10°C to +35°C
	Storage Humidity	< 75%RH
	Cooling Method	Ordinary or thermostat
Safety & EMC Requirement	Dielectric Strength	Primary to Secondary: 4000Vac 5mA, 3 secs.
	Radiation	Meeting EN55032,EN55014,FCC part 15, Class B
	Conduction	Meeting EN55032,EN55014, FCC part 15,Class B
	Harmonic Current Disturbance	Meeting IEC/EN61000-3-2:2014, Class A
	Voltage Fluctuation And Flicker	Meeting EN61000-3-3:2013
	Electrostatic Discharge	Meeting EN61000-4-2:2008 Contact Discharge $\pm 4\text{KV}$,Air Discharge $\pm 8\text{KV}$
	RF Field Strength Susceptibility	Meeting IEC/EN61000-4-3:2006+A1:2007+A2:2010
	Electrical Fast Transient	Meeting EN61000-4-4:2012, $\pm 1\text{KV}$
	Lightning Surge	Meeting EN61000-4-5:2014, $\pm 1\text{KV}$ (surge level can be extended to 6KV with an external circuit - please refer to MYRRA's website and catalogue for MYRRA SMPS application notes).
	Conducted Susceptibility	Meeting EN61000-4-6 : 2013
	Voltage Dips And Interruptions	Meeting EN61000-4-11 : 2004
	Safety Standards	Meet all requirements of : UL60950-1, UL62368-1, CAN/CSA22.2No.60950-1-07, CSA22.2No.62368-1-14, IEC/EN60950-1, IEC/EN60335-1,IEC/EN61558-2-16, IEC/EN62368-1, CE, VDE, ENEC Marks, UL certificate NO.E345767 VDE certificate NO. 40046353
Reliability Requirement	MTBF	Calculated by MIL-HDBK-217-F2 >200K Hours @230VAC input at max operation temperature; >550K Hours @230VAC input at 25deg.C
	Burn-In Test	The unit shall be burned in for 2~ 5hours under 230Vac input and DC with full load at an ambient temperature of 30~45 degrees C
Net Weight	About 16 grams per product unit	
Guarantee	This product meets RoHS standard	

Myrra reserve the right to change specifications in this document without notice

ONE OUTPUT 2W to 5W (49XXXC)



MAIN FEATURES

- 2.5 To 5W Small Compact Size - PCB Mount
- Single Output - Secondary Side Regulated
- Output Range : 3.3VDC - 30VDC
- Input Range : 85VAC - 265VAC/47 - 63Hz Or 120VDC -370VDC
- Very Low Standby Power Consumption < 0.1W
- Better Energetic Efficiency : Meet Requirements Of Energy Star And EC Code Of Conduct
- Encapsulated Design And Same Footprint As EI30 Transformer : Upgrade Your Application Without Redesign Of PCB

- Safety : Meets All Requirements of IEC/EN61558-2-16, IEC/EN60335-1, IEC/EN62368-1, UL62368-1, CSA C22.2NO.62368-1-14
- Materials : Uses UL 94-V0 Plastic And Resin
- EMC : Conducted And Radiated Emission conform To EN55032, FCC Part 15, CLASS B without any additional components.
- Immunity Conform To: IEC/EN61000-3-2 CLASS A, EN61000-3-3, EN61000-4-2, IEC/EN61000-4-3, EN61000-4-4, EN61000-4-5, EN61000-4-6, EN61000-4-8, EN61000-4-11

Part Number	Output Power (W)	Output voltage (Vdc)	Output current (mA)	Output Load Regulation (%)	Ambient Temp. (°C)	Min. Part Efficiency(%)
49033C	2.0	3.3	610	± 2	80	71
	2.75		830		70	
	5.0		1500		50	
49050C	2.0	5.0	400		85	70
	3.0		600		70	72
	5.0		1000		60	75
49090C	2.0	9.0	220		85	73
	3.0		330		70	75
	5.0		560		60	74
49120C	2.0	12	170		85	74
	3.0		250		70	76
	5.0		420		60	74
49150C	2.0	15	130		85	74
	3.0		200		70	77
	5.0		330		60	76
49180C	2.0	18	110		85	76
	3.0		170		70	78
	5.0		280		60	76
49240C	2.0	24	84		85	76
	3.0		125		70	80
	5.0		210		60	76
49300C	2.0	30	67		85	76
	3.0		100		70	80
	5.0		167		60	

DIMENSIONS and PINOUT

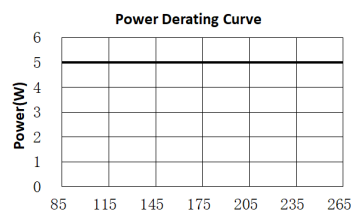
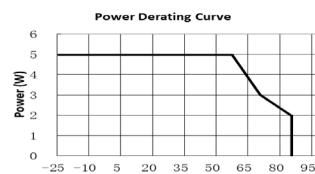
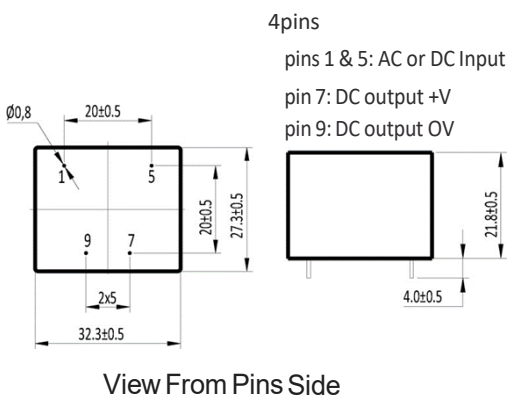

Model: 2.5 To 5 Watt		Specification
AC Input Characteristics	Rated AC input Voltage	100~240Vac Or 140VDC-340VDC
	AC Input Voltage Range	85~265Vac Or 120VDC-370VDC
	AC Input Frequency Range	47Hz~63Hz
	Rated AC Input Frequency	50/60Hz
	Input Current	0.2A Max@85Vac~265Vac@DC output with full load
	Standby Power	0.1W Max(Meet Requirements Of Energy Star And EC Code Of Conduct)
DC Output Characteristics	Output Voltage Accuracy	± 2%
	Output Voltage Line Regulation	± 0.5%
	Output Voltage Load Regulation	± 2%
	Ripple & Noise	Max 180mVp-p@ Rated AC input(The measuring will be terminated with a 47uF AL E-Cap and a 0.1uF Cer-Cap. An oscilloscope set at 20MHz bandwidth)
	Efficiency	See Table (Meet Requirements Of Energy Star And EC Code Of Conduct)
Protection Characteristics	Over Current Protection	The power supply shall automatically protect against over current. The power supply shall auto-recover normal operation after the fault condition is removed. No excessive heat, odour, or plastic deformation shall occur with no safety hazard during the fault.
	Output Short Circuit Protection	The power supply shall withstand a continuous output short without damage; The short may be applied before power on, or after power on. The power supply shall resume normal operation after the short is removed. No excessive heat, odour, or plastic deformation shall occur with no safety hazard during the fault.
	Over Temperature Protection	The power supply shall shut down when the junction temperature of PWM controller exceeds the thermal shutdown temperature, typically 140°C ±10°C
Environmental	Operation Temperature	-25°C ~+85°C (see table)
	Operation Humidity	10~ 90% RH(No Condensing) @ DC output with full load
	Storage Temperature	-10°C to +35°C
	Storage Humidity	< 75%RH
Safety & EMC Requirement	Dielectric Strength	Primary to Secondary: 4000Vac 5mA, 3 sec.
	Radiation	Meets EN55032,FCC part 15, Class B. under 3dB margin
	Conduction	Meets EN55032,FCC part 15,Class B. under 3dB margin
	Safety Standards	Meet all requirements of : Meet all requirements of : UL62368-1, CSA22.2No.62368-1-14, IEC/EN60335-1,IEC/EN61558-2-16, IEC/EN62368-1 CE, VDE,UKCA, ENEC Mark UL certificate NO.E345767 VDE certificate NO. 40053361
Reliability Requirement	MTBF	>550K Hours @ 230VAC input at 24deg.C and DC output with 5W load. >200K Hours @ 230VAC input at max operation temperature and DC output with 5W load <i>Calculated in accordance with MIL-HDBK-217-F2</i>
	Burn-In Test	The power supply is subject to a burn in test for 2~5hours under 230VAC input and DC full load at an ambient temperature of 30~45 degrees C
Net Weight	About 30 grams per product unit	
Guarantee	This product is in accordance with the European RoHS & REACH directives	

Myrra reserve the right to change specifications in this document without notice



ONE OUTPUT 2.5W to 5W

MAIN FEATURES

- 2.5 To 5W Small Compact Size - PCB Mount
- Single Output
- Output Range : 3.3VDC - 24VDC
- Input Range : 85VAC - 265VAC/47 - 63Hz Or 120VDC - 370VDC
- Very Low Standby Power Consumption < 0.2W
- Better Energetic Efficiency : Meet Requirements Of Energy Star And EC Code Of Conduct
- Encapsulated Design And Same Footprint As EI30 Transformer : Upgrade Your Application Without Redesign Of PCB

- Safety: Meets All Requirements of: IEC/EN61558-2-16, IEC/EN60950-1, IEC/EN60335-1, IEC/EN62368-1, UL60950-1, CSA22.2No.60950-1, CE, VDE, ENEC Mark
- Materials : Uses UL 94-V0 Plastic And Resin
- EMC : Conducted And Radiated Emissions Conform To EN55014 , EN55032 , CLASS B
- Immunity Conform To: IEC/EN61000-3-2 CLASS A, EN61000-3-3, EN61000-4-2, IEC/EN61000-4-3, EN61000-4-4, EN61000-4-5, EN61000-4-6, IEC61000-4-8, EN61000-4-11

Part Number	Output Power (W)	Output voltage (Vdc)	Output current (mA)	Output Load Regulation (%)	Max. Operating Ambient (°C)	Min. Part Efficiency(%)
47121	2.5	3.3	750	± 2	70	65
47122	2.75	5	550			68
47123	2.5	9	270			72
47124		12	210			74
47125		15	170			75
47126		24	110			77
47151		4.5	3.3			1350
47152	5		900		68	
47153	5	9	550		72	
47154		12	420		75	
47155		15	320		76	
47156		24	220		79	
47157	4.5	3.8	1180		50	66

Special Version : 4712xSLI and 4715xSLI = 19.2mm case height (x=1, 2, 3, 4, 5, 6 or 7)

DIMENSIONS and PINOUT

4 pins
 pins 1 & 5: AC or DC Input
 pin 7 : DC output +V
 pin 9 : DC output 0V

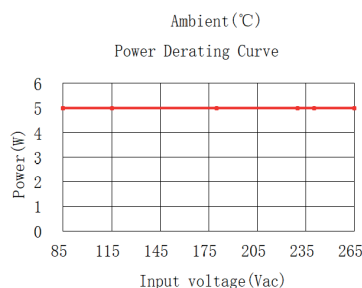
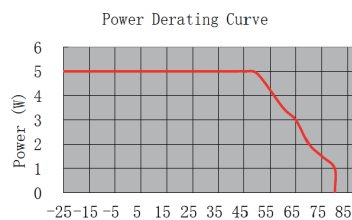
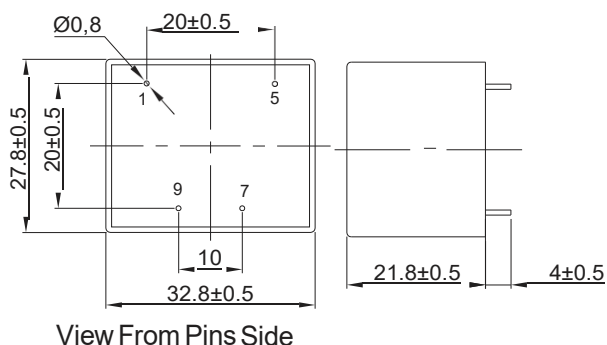

Model: 2.5 To 5 Watt		Specification
AC Input Characteristics	Rated AC input Voltage	100~240Vac Or 140VDC-340VDC
	AC Input Voltage Range	85~265Vac Or 120VDC-370VDC
	AC Input Frequency Range	47Hz~63Hz
	Rated AC Input Frequency	50/60Hz
	Input Current	0.2A Max@85Vac~265Vac@ DC output at full load
	Standby Power	0.3W Max(Meet Requirements Of Energy Star And EC Code Of Conduct)
DC Output Characteristics	Output Voltage Accuracy	± 5%
	Output Voltage Line Regulation	± 3%
	Output Voltage Load Regulation	± 5%
	Ripple & Noise	Max 200mVp-p@ Rated AC input(The measuring will be terminated with a 47uF AL E-Cap and a 0.1uF Cer-Cap. An oscilloscope set at 20MHz bandwidth)
	Efficiency	See Table (Meet Requirements Of Energy Star And EC Code Of Conduct)
Protection Characteristics	Over Current Protection	The power supply shall automatic protection. The power supply shall autorecovery normal operation after the deformation is removed. No excessive heat, odor, or plastic deformation shall occur, no safety hazard
	Output Short Circuit Protection	The power supply shall withstand a continuous output short without damage in 24 hours ; The short may be applied before power on, or after power on ; The power supply shall resume normal operation after the short is removed, no excessive heat, odor, or plastic deformation shall occur, no safety hazard
	Over Temperature Protection	The power supply shall shut down when the junction temperature of PWM controller exceeds the thermal shutdown temperature, typically 140°C ±10°C
Environmental	Operation Temperature	-25°C ~+ (see table)
	Operation Humidity	10~ 90% RH(No Condensing) @ DC output with full load
	Storage Temperature	-10°C to +35°C
	Storage Humidity	< 75%RH
Safety & EMC Requirement	Dielectric Strength	Primary to Secondary: 4000Vac 5mA, 3 sec.
	Radiation	Meet EN55032,EN55014 , Class B. under 3dB margin
	Conduction	Meet EN55032,EN55014, Class B. under 3dB margin
	Safety Standards	Meet all requirements of UL60950-1, CSA22.2No.60950-1-07JEC/EN60950-1, IEC/EN60335-1, IEC/EN61558-2-16, IEC/EN62368-1,CE,VDE, And ENEC Mark VDE Approval No. 40034334 UL Approval No.E345767
Reliability Requirement	MTBF	Calculated by MIL-HDBK-217-F2 550K Hours Min. @230VAC input, 25deg.C
	Burn-In Test	The unit shall be burned in for 2~ 5hours under 230Vac input and DC with full load at an ambient temperature of 30~45 degrees C
Net Weight	About 30 grams per product unit	
Guarantee	This product meet to RoHS standard	

Myrra reserve the right to change specifications in this document without notice

ONE OUTPUT 2.4W to 5W



MAIN FEATURES

- 2.4W to 5W Small Compact Size - PCB Mount
- Single Output
- Output Range : 5.5VDC - 24VDC
- Input Range : 85VAC - 265VAC/47 - 63Hz Or 120VDC - 370VDC
- Very Low Standby Power Consumption < 0.3W
- Better Energetic Efficiency : Meet Requirements Of Energy Star
- Encapsulated Design And Same Footprint As EI30 Transformer : Upgrade Your Application Without Redesign Of PCB

- Safety: Meets All Requirements of: IEC/EN61558-2-16, IEC/EN60950-1, IEC/EN60335-1, UL60950-1, IEC/EN62368-1, CSA22.2No.60950-1-07, CE, VDE, ENEC Mark
- Materials: Uses UL 94-V0 Plastic And Resin
- EMC: Conducted And Radiated Emissions Conform To EN55014, EN55032, CLASS B
- Immunity Conform To: IEC/EN61000-3-2 CLASS A, EN61000-3-3, EN61000-4-2, IEC/EN61000-4-3, EN61000-4-4, EN61000-4-5, EN61000-4-6, EN61000-4-8, EN61000-4-11

Part Number	Output Power (W)	Output Voltage (Vdc)	Output Current (mA)	Output Load Regulation (%)	Ambient (°C)	Min. Part Efficiency(%)
47114	2.4	12	200	± 5	70	74
47132	2.5	5	500			68
47133	3.2	9	360			73
47134		12	270			75
47135		18	180			78
47136		24	130			80
47162	5	5	900		50	68
47163		9	560			73
47164		12	420			75
47165		18	280			78
47166		24	210			80

DIMENSIONS and PINOUT

4 pins
 pins 1 & 5: AC or DC Input
 pin 7 : DC output +V
 pin 9 : DC output OV

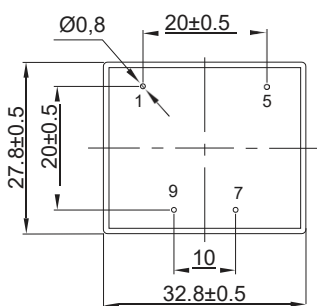

View From Pins Side

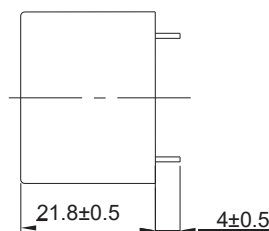

Power Derating Curve

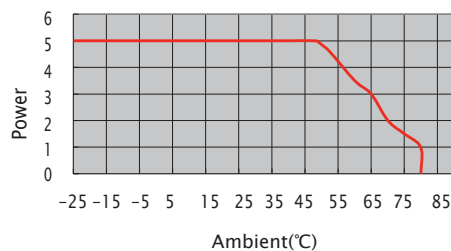

Power Derating Curve

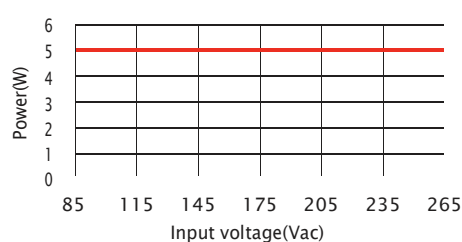

Model: 2.5 To 5 Watt		Specification
AC Input Characteristics	Rated AC input Voltage	100~240Vac Or 140VDC-340VDC
	AC Input Voltage Range	85~265Vac Or 120VDC-370VDC
	AC Input Frequency Range	47Hz~63Hz
	Rated AC Input Frequency	50/60Hz
	Input Current	0.2A Max@85Vac~265Vac@DC output with full load
	Standby Power	0.3W Max(Meet Requirements Of Energy Star And EC Code Of Conduct)
DC Output Characteristics	Output Voltage Accuracy	± 5%
	Output Voltage Line Regulation	± 3%
	Output Voltage Load Regulation	± 5%
	Ripple & Noise	Max 200mVp-p@ Rated AC input(The measuring will be terminated with a 47uF AL E-Cap and a 0.1uF Cer-Cap. An oscilloscope set at 20MHz bandwidth)
	Efficiency	See Table (Meet Requirements Of Energy Star And EC Code Of Conduct)
Protection Characteristics	Over Current Protection	The power supply shall automatic protection. The power supply shall autorecovery normal operation after the deformation is removed. No excessive heat, odor, or plastic deformation shall occur, no safety hazard
	Output Short Circuit Protection	The power supply shall withstand a continuous output short without damage in 24 hours ; The short may be applied before power on, or after power on ; The power supply shall resume normal operation after the short is removed, no excessive heat, odor, or plastic deformation shall occur, no safety hazard
	Over temperature protection	The power supply shall shut down when the junction temperature of PWM controller exceeds the thermal shutdown temperature, typically 140°C ±10°C
Environmental	Operation Temperature	-25°C ~+ (see table)
	Operation Humidity	10~ 90% RH(No Condensing) @ DC output with full load
	Storage Temperature	-10°C to +35°C
	Storage Humidity	< 75%RH
Safety & EMC Requirement	Dielectric Strength	Primary to Secondary: 4000Vac 5mA, 3 sec.
	Radiation	Meet EN55032,EN55014 , Class B. under 3dB margin
	Conduction	Meet EN55032,EN55014, Class B. under 3dB margin
	Safety Standards	Meet all requirements of UL60950-1,CSA22.2No.60950-1-07,IEC/EN60950-1,IEC/EN60335-1,IEC/EN61558-2-16,IEC/EN62368-1 CE,VDE, And ENEC Mark VDE Approval No. 40034334 UL Approval No.E345767
Reliability Requirement	MTBF	Calculated by MIL-HDBK-217-F2 550K Hours Min. @230VAC input, 25deg.C
	Burn-In Test	The unit shall be burned in for 2~5hours under 230Vac input and DC with full load at an ambient temperature of 30~45 degrees C
Net Weight	About 30 grams per product unit	
Guarantee	This product meet to RoHS standard	

Myrra reserve the right to change specifications in this document without notice

TWO OUTPUTS - COMMON 3W to 5W



MAIN FEATURES

- 3W To 5W Small Compact Size - PCB Mount
- Two Common Output
- Output Voltage Accuracy :
See Table For 15 to 100% Rated Load Of Each Output (includes line and load variations)
- Input Range : 85VAC - 265VAC/47 - 63Hz Or 120VDC - 370VDC
- Very Low Standby Power Consumption < 0.2W
- Better Energetic Efficiency : Meet Requirements Of Energy Star

- Encapsulated Design And Same Footprint As EI30Transformer : Upgrade Your Application Without Redesign Of PCB
- Safety:Meets All Requirements of:IEC/EN61558-2-16, IEC/EN60950-1, IEC/EN60335-1, UL60950-1, IEC/EN62368-1, CSA22.2No.60950-1-07, CE, VDE, ENEC Mark
- Materials: Uses UL 94-V0 Plastic And Resin
- EMC: Conducted And Radiated Emissions Conform To EN55014 , EN55032, CLASS B
- Immunity Conform To:
IEC/EN61000-3-2 CLASS A, EN61000-3-3, EN61000-4-2, IEC/EN61000-4-3, EN61000-4-4,EN61000-4-5, EN61000-4-6, EN61000-4-8,EN61000-4-11

Part Number	Output Power (W)	Output Voltage (Vdc)	Output Current (mA)	Output Load Regulation (%)	Max.Operating Ambient (°C)	Min. Part Efficiency(%)
47243	4.7	(+)10.5	380	± 3	50	72
		(+) 7.0	100	± 15		
47244	5	(+) 15	300	± 3	70	65
		(+) 7.0	70	± 15		
47245	3.2	(+) 12	130	± 5	60	73
		(+) 5.5	300	± 10		
47246	4	(+) 5.0	400 (600max)	± 3	60	73
		(+) 12	170	± 15		
47247	4	(+) 15	130	± 8	60	73
		(+) 15	130	± 8		

Notes : The dual DC Voltage Outputs share a Common OV reference.
Power deration must be considered at higher Operating Ambient Temperatures.

DIMENSIONS and PINOUT

- 5 pins
pins 1 & 5: AC or DC Input
pin 6: Common output 0V
pin 7: DC output I
pin 10: DC output II

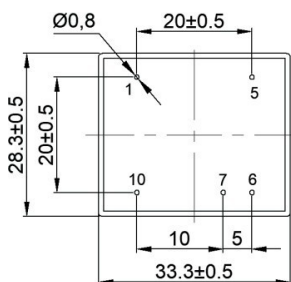

View From Pins Side

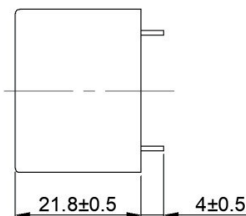

Power Derating Curve

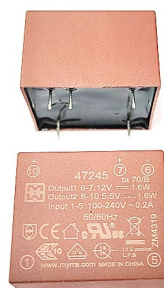
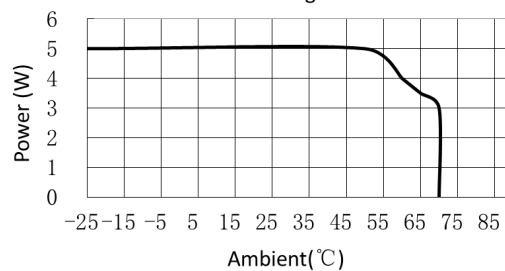

Model: Two Common Outputs 3 TO 5W		Specification
AC Input Characteristics	Rated AC input Voltage	100~240Vac Or 140VDC-340VDC
	AC Input Voltage Range	85~265Vac Or 120VDC-370VDC
	AC Input Frequency Range	47Hz~63Hz
	Rated AC Input Frequency	50/60Hz
	Input Current	0.2A Max@85Vac~265Vac@DC output with full load
	Standby Power	0.2W Max (Meet Requirements Of Energy Star And EC Code Of Conduct)
DC Output Characteristics	Output Voltage Accuracy	See Table For 15 To 100% Rated Load Of Each Output (includes line and load variations)
	Efficiency	See Table(Meet Requirements Of Energy Star And EC Code Of Conduct)
Protection Characteristics	Over Current Protection	The power supply shall automatic protection. The power supply shall auto recovery normal operation after the deformation is removed. No excessive heat, odor, or plastic deformation shall occur, no safety hazard
	Output Short Circuit Protection	The power supply shall withstand a continuous output short without damage in 24 hours; The short may be applied before power on, or after power on ; The power supply shall resume normal operation after the short is removed, no excessive heat, odor, or plastic deformation shall occur, no safety hazard
	Over Temperature Protection	The power supply shall shut down when the junction temperature of PWMcontroller exceeds the thermal shutdown temperature, typically 140°C±10°C.
Environmental	Operation Temperature	-25°C ~ +Ta (see table)
	Operation Humidity	10~ 90% RH(No Condensing) @DC output with full load
	Storage Temperature	-10'C to +35'C
	Storage Humidity	< 75%RH
Safety & EMC Requirement	Dielectric Strength	Primary to Secondary: 4000Vac 5mA, 3 sec.
	Radiation	Meet EN55032,EN55014, Class B. under 3dB margin
	Conduction	Meet EN55032,EN55014,Class B. under 3dB margin
	Safety Standards	Meet all requirements of UL60950-1,CSA22.2No.60950-1-07,IEC/EN60950-1, IEC/EN60335-1,IEC/EN61558-2-16,IEC/EN62368-1 CE,VDE, And ENEC Mark VDE Approval No. 40034334 UL Approval No.E345767
Reliability Requirement	MTBF	Calculated by MIL-HDBK-217-F2 550K Hours Min. @230VAC input, 25deg.C
	Burn-In Test	The unit shall be burned in for 2~5hours under 230Vac input and DC with full load at an ambient temperature of 30~45 degrees C
Net Weight	About 30 grams per product unit	
Guarantee	This product meet to RoHS standard	

Myrra reserve the right to change specifications in this document without notice

TWO OUTPUTS - ISOLATED 3.5W to 4W



MAIN FEATURES

- Small Compact Size - P C B Mount
- Two Isolated Output
- Output Voltage Accuracy :
See Table For 15 to 100% Rated Load Of Each Output(includes line and load variations)
- Input Range : 85VAC - 265VAC/47 - 63Hz Or 120VDC - 370VDC
- Very Low Standby Power Consumption < 0.2W
- Better Energetic Efficiency : Meet Requirements Of Energy Star

- Encapsulated Design And Same Footprint As EI30Transformer : Upgrade Your Application Without Redesign Of PCB
- Safety:Meets All Requirements of: IEC/EN61558-2-16, IEC/EN60950-1, IEC/EN60335-1, UL60950-1, IEC/EN62368-1,CSA22.2No.60950-1-07, CE, VDE, ENEC Mark
- Materials : Uses UL 94-V0 Plastic And Resin
- EMC : Conducted And Radiated Emissions Conform To EN55014 , EN55032 , CLASS B
- Immunity Conform To:
IEC/EN61000-3-2 CLASS A, EN61000-3-3, EN61000-4-2, IEC/EN61000-4-3, EN61000-4-4,EN61000-4-5, EN61000-4-6, EN61000-4-8,EN61000-4-11

Part Number	Output Power (W)	Output Voltage (Vdc)	Output Current (mA)	Output Load Regulation (%)	Max.Operating Ambient (°C)	Min. Part Efficiency(%)
47252	3.5	5	350 (600 max)	± 3	60	60
		5	350	± 15		
47254	4	12	165 (300max)	± 5		72
		12	165	± 15		
47255		15	135 (200 max)	± 5		73
		15	135	± 15		
47257		5	400 (600 max)	± 3		68
		12	170	± 15		
47258		18	150 (200 max)	± 5		72
		8	150	± 15		

DIMENSIONS and PINOUT

6 pins

pins 1 & 5: AC or DC Input
pin 6: DC output 1 0V
pin 7: DC output 1 +V
pin 9: DC output 2 0V
pin 10: DC output 2 +V

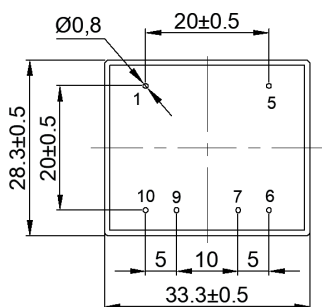

View From Pins Side

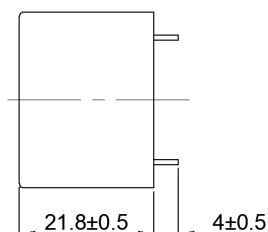

Power Derating Curve

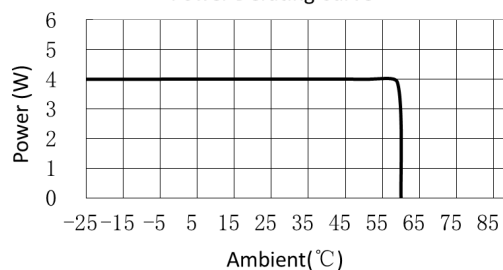

Power Derating Curve

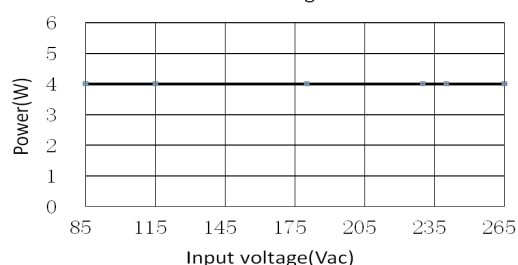

Model : Two Common Outputs 3 TO 5W		Specification
AC Input Characteristics	Rated AC input Voltage	100~240Vac Or 140VDC-340VDC
	AC Input Voltage Range	85~265Vac Or 120VDC-370VDC
	AC Input Frequency Range	47Hz~63Hz
	Rated AC Input Frequency	50/60Hz
	Input Current	0.2A Max@85Vac~265Vac@ DC output with full load
	Standby Power	0.2W Max (Meet Requirements Of Energy Star And EC Code Of Conduct)
DC Output Characteristics	Output Voltage Accuracy	See Table For 15 To 100% Rated Load Of Each Output (includes line and load variations)
	Efficiency	See Table(Meet Requirements Of Energy Star And EC Code Of Conduct)
Protection Characteristics	Over Current Protection	The power supply shall automatic protection. The power supply shall auto recovery normal operation after the deformation is removed. No excessive heat, odor, or plastic deformation shall occur, no safety hazard
	Output Short Circuit Protection	The power supply shall withstand a continuous output short without damage in 24 hours; The short may be applied before power on, or after power on ; The power supply shall resume normal operation after the short is removed, no excessive heat, odor, or plastic deformation shall occur, no safety hazard
	Over Temperature Protection	The power supply shall shut down when the junction temperature of PWMcontroller exceeds the thermal shutdown temperature, typically140°C±10°C.
Environmental	Operation Temperature	-25°C ~ +Ta (see table)
	Operation Humidity	10~ 90% RH(No Condensing) @ DC output with full load
	Storage Temperature	-10°C to +35°C
	Storage Humidity	< 75%RH
Safety & EMC Requirement	Dielectric Strength	Primary to Secondary: 4000Vac 5mA, 3 sec.
	Radiation	Meet EN55032,EN55014, Class B. under 3dB margin
	Conduction	Meet EN55032,EN55014,Class B. under 3dB margin
	Safety Standards	Meet all requirements of UL60950-1, CSA22.2No.60950-1-07, IEC/EN60950-1, IEC/EN60335-1,IEC/EN61558-2-16,IEC/EN62368-1 CE,VDE, And ENEC Mark VDE Approval No. 40034334 UL Approval No.E345767
Reliability Requirement	MTBF	Calculated by MIL-HDBK-217-F2 550K Hours Min. @230VAC input, 25deg.C
	Burn-In Test	The unit shall be burned in for 2~5hours under 230Vac input and DC with full load at an ambient temperature of 30~45 degrees C
Net Weight	About 30 grams per product unit	
Guarantee	This product meet to RoHS standard	

Myrra reserve the right to change specifications in this document without notice

ONE OUTPUT 7.5W



MAIN FEATURES

- 7.5W Small Compact Size - PC B Mount
- Single Output
- Output Range : 3.3VDC - 24VDC
- Input Range : 85VAC - 265VAC/47 - 63Hz Or 120VDC - 370VDC
- Very Low Standby Power Consumption < 0.15W
- Better Energetic Efficiency : Meet Requirements Of Energy Star
- Encapsulated Design And Same Footprint As EI38 Transformer : Upgrade Your Application Without Redesign Of PCB

- Safety : Meets All Requirements of: IEC/EN61558-2-16, IEC/EN60950-1, IEC/EN60335-1, UL60950-1, IEC/EN62368-1, CAN/CSA22.2No.60950-1-07, CE, VDE, ENEC Mark
- Materials : Uses UL 94-V0 Plastic And Resin
- EMC : Conducted And Radiated Emissions Conform To EN55014,EN55032,FCC Part15, CLASS B
- Immunity Conform To: IEC/EN61000-3-2 CLASS A, EN61000-3-3, EN61000-4-2, IEC/EN61000-4-3, EN61000-4-4,EN61000-4-5, EN61000-4-6, EN61000-4-8,EN61000-4-11

Part Number	Output Power (W)	Output Voltage (Vdc)	Output Current (mA)	Output Load Regulation (%)	Max.Operating Ambient (°C)	Min. Part Efficiency(%)
47206	7.5	3.3	2270	± 3	50	74
47200		5	1500	± 2	70	77
47201		9	830			80
47202		12	625			82
47203		15	500			
47204		18	420			
47205		24	310			

DIMENSIONS and PINOUT

4 pins
 pins 1 & 5: AC or DC Input
 pin 7 : DC output +V
 pin 9 : DC output OV

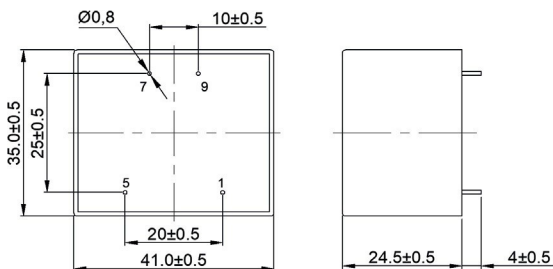

View From Pins Side

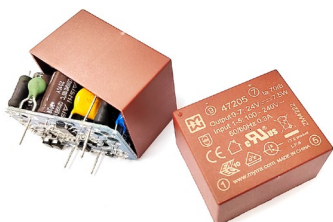

Power Derating Curve

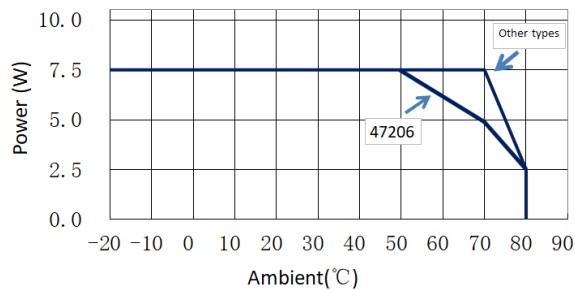

Power Derating Curve

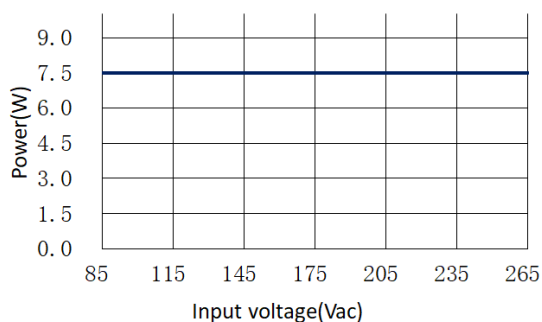

Model: 7.5 Watt		Specification
AC Input Characteristics	Rated AC input Voltage	100~240Vac Or 140VDC-340VDC
	AC Input Voltage Range	85~265Vac Or 120VDC-370VDC
	AC Input Frequency Range	47Hz~63Hz
	Rated AC Input Frequency	50/60Hz
	Input Current	0.3A Max@85Vac~265Vac@DC with full load
	Standby Power	0.15W Max(Meet Requirements Of Energy Star And EC Code Of Conduct)
DC Output Characteristics	Output Voltage Accuracy	± 2% (5V,9V,12V,15V,18V,24V Types) - ± 3%(3.3V Type)
	Output Voltage Line Regulation	± 0.5%
	Output Voltage Load Regulation	± 1%(5V,9V,12V,15V,18V,24V Types) ± 3%(3.3V Type)
	Ripple & Noise	Max180mVp-p@ Rated AC input, at nominal line (The measuring will be terminated with a 47uF AL E-Cap and a 0.1uF Cer-Cap. An oscilloscope set at 20MHz bandwidth)
	Efficiency	Meet Requirements Of Energy Star And EC Code Of Conduct
Protection Characteristics	Over Current Protection	The power supply shall automatic protection. The power supply shall auto recovery normal operation after the deformation is removed. No excessive heat, odor, or plastic deformation shall occur, no safety hazard
	Output Short Circuit Protection	The power supply shall withstand a continuous output short without damage in 24 hours; The short may be applied before power on, or after power on; The power supply shall resume normal operation after the short is removed, no excessive heat, odor, or plastic deformation shall occur, no safety hazard
Environmental	Operation Temperature	-20°C ~ +Ta (see table)
	Operation Humidity	10~ 90% RH(No Condensing) @ full load
	Storage Temperature	-40°C~ +85°C
	Storage Humidity	5%~95%
Safety & EMC Requirement	Dielectric Strength	Primary to Secondary: 4000Vac 5mA, 3 sec.
	Radiation	Meet EN55032,EN55014,FCC part 15, Class B. under 3dB margin
	Conduction	Meet EN55032,EN55014, FCC part 15,Class B. under 3dB margin
	Safety Standards	Meet all requirements of UL60950-1,CAN/CSA22.2No.60950-1-07,IEC/EN60950-1,IEC/EN60335-1,IEC/EN61558-2-16,IEC/EN62368-1 CE,VDE, And ENEC Mark VDE Approval No. 40041563 UL Approval No.E345767
Reliability Requirement	MTBF	Calculated by MIL-HDBK-217-F2 550K Hours Min. @230VAC input, 25deg.C
	Burn-In Test	The unit shall be burned in for 2~5hours under 230Vac input and DC with full load at an ambient temperature of 30~45 degrees C
Net Weight	About 56 grams per product unit	
Guarantee	This product meet to RoHS standard	

Myrra reserve the right to change specifications in this document without notice

ONE OUTPUT 5W to 10W (49XXxE)



MAIN FEATURES

- 5 To 10W Small Compact Size - PCB Mount
- Single Output - Secondary Side Regulated
- Output Range : 3.3VDC - 30VDC
- Input Range : 85VAC - 265VAC/47 - 63Hz Or 120VDC -370VDC
- Very Low Standby Power Consumption < 0.1W
- Better Energetic Efficiency : Meet Requirements Of Energy Star And EC Code Of Conduct

Encapsulated Design And Same Footprint As EI38 Transformer : Upgrade Your Application Without Redesign Of PCB

- Safety : Meets All Requirements of IEC/EN61558-2-16, IEC/EN60335-1, IEC/EN62368-1, UL62368-1, CSA C22.2NO.62368-1-14, CE, VDE, ENEC, UKCA Mark.
- Materials : Uses UL 94-V0 Plastic And Resin
- EMC : Conducted And Radiated Emission conform To EN55032, FCC Part 15, CLASS B without any additional components.
- Immunity Conform To: IEC/EN61000-3-2 CLASS A, EN61000-3-3, EN61000-4-2, IEC/EN61000-4-3, EN61000-4-4, EN61000-4-5, EN61000-4-6, EN61000-4-8, EN61000-4-11

Part Number	Output Power (W)	Output voltage (Vdc)	Output current (mA)	Output Load Regulation (%)	Ambient Temp. (°C)	Min. Part Efficiency
49033E	10	3.3	2700	± 2	60	68%
	7.5		2270		70	
	5.0		1500		80	
49050E	10	5.0	2000		60	73%
	7.5		1500		70	70%
	5.0		1000		80	
49090E	10	9.0	1100		60	79%
	7.5		830		75	74%
	5.0		550		80	
49120E	10	12	830		60	80%
	7.5		625		75	75%
	5.0		420		80	
49150E	10	15	670	60	81%	
	7.5		500	75	76%	
	5.0		330	80		
49180E	10	18	560	60	81%	
	7.5		420	75	76%	
	5.0		280	80		
49240E	10	24	420	60	81%	
	7.5		310	75	76%	
	5.0		210	80		
49300E	10	30	333	60	81%	
	7.5		250	75	76%	
	5.0		167	80		

DIMENSIONS and PINOUT

4pins

pins 1 & 5: AC or DC Input

pin 7: DC output +V

pin 9: DC output OV

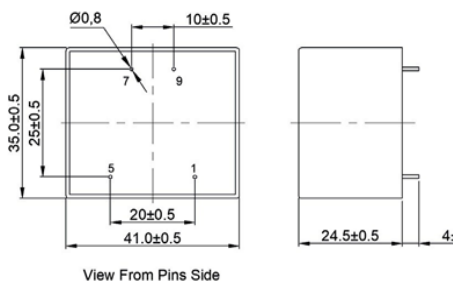

Power Derating Curve

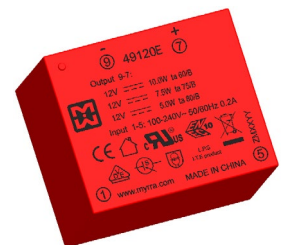
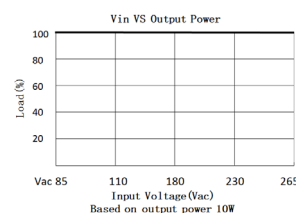
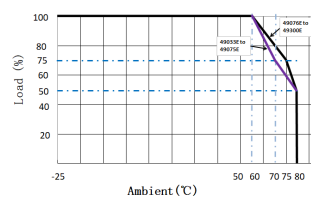

Model: 5W To 10Watt		Specification
AC Input Characteristics	Rated AC input Voltage	100~240Vac Or 140VDC-340VDC
	AC Input Voltage Range	85~265Vac Or 120VDC-370VDC
	AC Input Frequency Range	47Hz~63Hz
	Rated AC Input Frequency	50/60Hz
	Input Current	0.35A Max@85Vac~265Vac@DC output with full load
	Standby Power	0.1W Max(Meet Requirements Of Energy Star And EC Code Of Conduct)
DC Output Characteristics	Output Voltage Accuracy	± 2%
	Output Voltage Line Regulation	± 0.5%
	Output Voltage Load Regulation	± 2%
	Ripple & Noise	Max 180mVp-p@ Rated AC input(The measuring will be terminated with a 47uF AL E-Cap and a 0.1uF Cer-Cap. An oscilloscope set at 20MHz bandwidth)
	Efficiency	See Table (Meet Requirements Of Energy Star And EC Code Of Conduct)
Protection Characteristics	Over Current Protection	The power supply shall automatically protect against over current. The power supply shall auto-recover normal operation after the fault condition is removed. No excessive heat, odour, or plastic deformation shall occur with no safety hazard during the fault.
	Output Short Circuit Protection	The power supply shall withstand a continuous output short without damage; The short may be applied before power on, or after power on. The power supply shall resume normal operation after the short is removed. No excessive heat, odour, or plastic deformation shall occur with no safety hazard during the fault.
	Over Temperature Protection	The power supply shall shut down when the junction temperature of PWM controller exceeds the thermal shutdown temperature, typically 140°C ±10°C
Environmental	Operation Temperature	-25°C ~+80°C (see table)
	Operation Humidity	10~ 90% RH(No Condensing) @ DC output with full load
	Storage Temperature	-10'C to +35'C
	Storage Humidity	< 75%RH
Safety & EMC Requirement	Dielectric Strength	Primary to Secondary: 4000Vac 5mA, 3 sec.
	Radiation	Meets EN55032,FCC part 15, Class B. under 3dB margin
	Conduction	Meets EN55032,FCC part 15,Class B. under 3dB margin
	Safety Standards	Meet all requirements of : UL62368-1, CSA C22.2NO.62368-1-14, IEC/EN60335-1,IEC/EN61558-2-16, IEC/EN62368-1, CE, VDE,UKCA, ENEC Mark UL certificate NO.E345767
Reliability Requirement	MTBF	>200K Hours @230VAC input at max operation temperature; >550K Hours @230VAC input at 25deg.C Calculated in accordance with MIL-HDBK-217-F2
	Burn-In Test	The power supply is subject to a burn in test for 2~5hours under 230VAC input and DC full load at an ambient temperature of 30~45 degrees C
Net Weight	About 56 grams per product unit	
Guarantee	This product is in accordance with the European RoHS & REACH directives	

Myrra reserve the right to change specifications in this document without notice

ONE OUTPUT 10W



MAIN FEATURES

- 10W Small Compact Size - PCB Mount
- Single Output
- Output Range : 3.3VDC - 24VDC
- Input Range : 85VAC - 265VAC/47 - 63Hz Or 120VDC - 370VDC
- Very Low Standby Power Consumption < 0.10W
- Better Energetic Efficiency : Meet Requirements Of Energy Star
- Encapsulated Design And Same Footprint As EI48 Transformer : Upgrade Your Application Without Redesign Of PCB

- Safety : Meets All Requirements of: IEC/EN61558-2-16, IEC/EN60950-1, IEC/EN60335-1, UL60950-1, IEC/EN62368-1, CAN/CSA22.2No.60950-1-07, CE, VDE, ENECMark
- Materials : Uses UL 94-V0 Plastic And Resin
- EMC : Conducted And Radiated Emissions Conform To EN55014 , EN55032 , FCC Part 15 CLASS B
- Immunity Conform To: IEC/EN61000-3-2 CLASS A, EN61000-3-3, EN61000-4-2, IEC/EN61000-4-3, EN61000-4-4, EN61000-4-5, EN61000-4-6, EN61000-4-8, EN61000-4-11

Part Number	Output Power (W)	Output Voltage (Vdc)	Output Current (mA)	Output Load Regulation (%)	Max. Operating Ambient (°C)	Min. Part Efficiency(%)
47210	10	5	2000	± 3	60	74
47211		9	1100	± 2		80
47212		12	830			82
47213		15	670			
47214		18	560		50	72
47215		24	420			
47216		3.3	3000	± 4		

DIMENSIONS and PINOUT

4 pins

pins 1 & 5: AC or DC Input

pin 7 : DC output +V

pin 9 : DC output OV

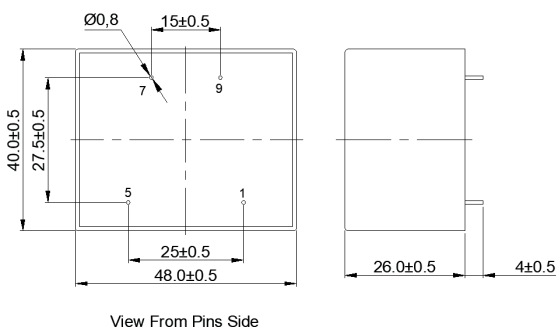

Power Derating Curve

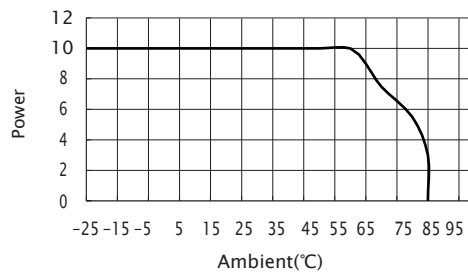

Power Derating Curve

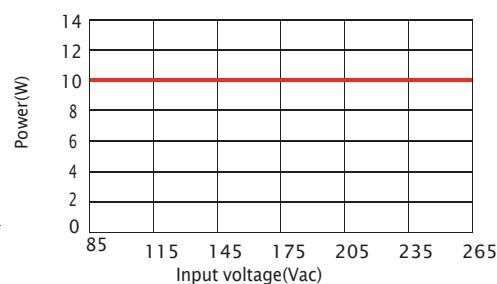

Model: 10 Watt		Specification
AC Input Characteristics	Rated input Voltage	100~240Vac Or 140VDC-340VDC
	Input Voltage Range	85~265Vac Or 120VDC-370VDC
	AC Input Frequency Range	47Hz~63Hz
	Rated AC Input Frequency	50/60Hz
	Input Current	0.4A Max@85Vac~265Vac@ DC output with full load
	Standby Power	0.1W Max(Meet Requirements Of Energy Star And EC Code Of Conduct)
DC Output Characteristics	Output Voltage Accuracy	± 2% (9V,12V,15V,18V,24V Types), ± 3% (5V Type), ± 4%(3.3V Type)
	Output Voltage Line Regulation	± 0.5%(9V,12V,15V,18V,24V Types), ± 1%(3.3V and 5V Types)
	Output Voltage Load Regulation	± 1%(9V,12V,15V,18V,24V Types) ± 3% (5V Type), ± 4%(3.3V Type)
	Ripple & Noise	Max150mVp-p@RatedACinput (Themeasuringwillbeterminatedwitha47uFALE-Capanda 0.1uF Cer-Cap. An oscilloscope set at 20MHz bandwidth)
	Efficiency	Meets Requirements Of Energy Star And EC Code Of Conduct
Protection Characteristics	Over Current Protection	The power supply shall automatic protection. The power supply shall auto-recovery normal operation after the deformation is removed. No excessive heat, odor, or plastic deformation shall occur, no safety hazard
	Output Short Circuit Protection	The power supply shall withstand a continuous output short without damage in 24 hours; The sho may be applied before power on, or after power on; The power supply shall resume normal operation after the short is removed, no excessive heat, odor, or plastic deformation shall occur, n safety hazard
Environmental	Operation Temperature	-25°C ~ +Ta (see table)
	Operation Humidity	10~ 90% RH(No Condensing) @ DC output with full load
	Storage Temperature	-10°C to +35°C
	Storage Humidity	< 75%RH
Safety & EMC Requirement	Dielectric Strength	Primary to Secondary: 4000Vac 5mA, 3 sec .
	Radiation	Meeting EN55032,EN55014,FCC part 15, Class B.
	Conduction	Meeting EN55032,EN55014, FCC part 15,Class B.
	Safety Standards	Meet all requirements of : UL60950-1, CAN/CSA22.2No.60950-1-07, IEC/EN60335-1,IEC/EN61558-2-16, IEC/EN62368-1 CE, VDE, ENEC Mark UL certificate NO.E345767 VDE certificate No.40044416
Reliability Requirement	MTBF	Calculated by MIL-HDBK-217-F2 5V ,9V,12V,15V,18V,24V Types: 200K Hours Min. @230VAC input, 60deg.C 3.3V type:200K Hours Min. @230VAC input, 50deg.C
	Burn-In Test	The unit shall be burned in for 2~ 5hours under 230Vac input and DC with full load at an ambienttemperature of 30~45 degreesC
Net Weight	About 80.2 grams per product unit.	
Guarantee	This product meet to RoHS standard	

Myrra reserve the right to change specifications in this document without notice

ONE OUTPUT 20W (49XXXG)



MAIN FEATURES

- 20W Small Compact Size - PCB Mount
- Single Output
- Output Range : 3.3VDC - 30VDC
- Input Range: 85VAC - 265VAC/47 - 63Hz Or 120VDC - 370VDC
- Very Low Standby Power Consumption = 0.15W
- High Energetic Efficiency: Meet Requirements Of Energy Star And EC Code Of Conduct
- Encapsulated Design PCB Total Power Solution

- Safety: Meets with IEC/EN61558-2-16, IEC/EN60335-1, UL62368-1, IEC/EN62368-1, CSA C22.2NO.62368-1-14, CE, UKCA Mark
- Materials: Uses UL 94-V0 Plastic And Resin
- EMC : Conducted And Radiated Emissions Conform To EN55032, FCC Part15, CLASS B
- Immunity Conform To: IEC/EN61000-3-2 CLASS A, EN61000-3-3, EN61000-4-2, IEC/EN61000-4-3, EN61000-4-4, EN61000-4-5, EN61000-4-6, EN61000-4-8, EN61000-4-11

Part Number	Output Power (W)	Output voltage (Vdc)	Output current (mA)	Output Load Regulation (%)	Ambient Temp. (°C)	Min. Part Efficiency (%)
49033G	13.5	3.3	4100	± 4	-25°C ~ +80°C	75
49050G	19	5	3800			78
49090G	20	9	2200	± 2 · 5		81
49120G		12	1667 (1800 max)			82
49150G		15	1333 (1400 max)			83
49180G		18	1111 (1140 max)			
49240G		24	833 (900 max)			
49300G		30	667 (720 max)			

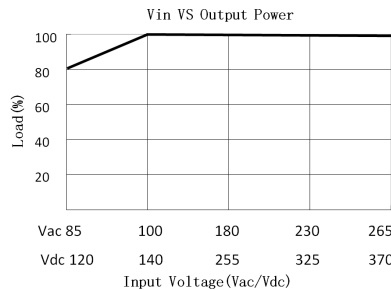
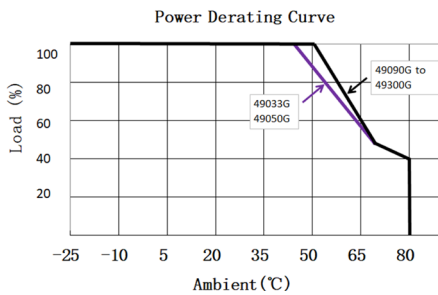

DIMENSIONS and PINOUT

- pin 1: AC(L) or DC(L) Input
- pin 5 : AC(N) or DC(-) Input
- pin 7 : DC output 0V
- pin 9 : DC output +V

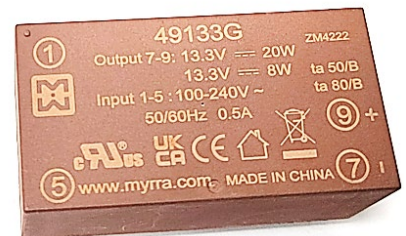
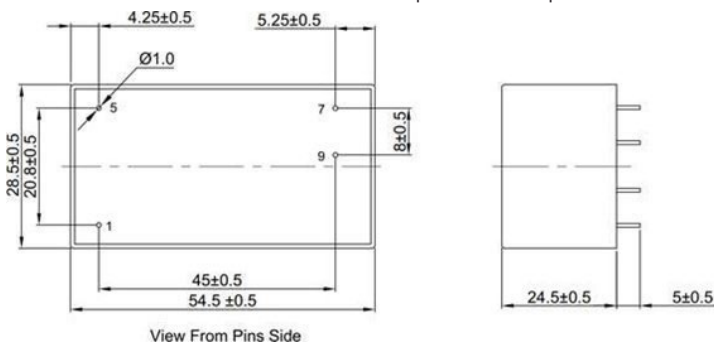

Model: 20 Watt		Specification
AC Input Characteristics	Rated input Voltage	100~240Vac Or 140VDC-340VDC
	Input Voltage Range	85~265Vac Or 120VDC-370VDC
	AC Input Frequency	47Hz~63Hz
	Rated AC Input Frequency	50/60Hz
	Input Current	0.5A Max@85Vac~265Vac@DC output with full load
	Standby Power	0.15W Max (Meets requirements Of Energy Star And EC Code Of Conduct)
DC Output Characteristics	Output Voltage Accuracy	± 2.5% (9V, 12V, 15V, 18V, 24V Types) ± 4% (3.3V Type, 5V Type)
	Output Voltage Line Regulation	+/- 1%
	Output Voltage Load Regulation	± 2.5% (9V, 12V, 15V, 18V, 24V Types) ± 4% (3.3V Type, 5V Type)
	Ripple & Noise	Max 180mVp-p @Rated AC input (The measuring will be terminated with a 47uF AL E-Cap and a 0.1uF Cer-Cap. An oscilloscope set at 20MHz bandwidth)
	Efficiency	Meets requirements Of Energy Star And EC Code Of Conduct
Protection Characteristics	Over Current Protection	The power supply shall automatic protection. The power supply shall auto-recovery normal operations after the deformation is removed. No excessive heat, odor, or plastic deformation shall occur with no safety hazard
	Output Short Circuit Protection	The power supply shall withstand a continuous output short without damage in 24 hours; The short may be applied before power on, or after power on; The power supply shall resume normal operation after the short is removed, no excessive heat, odor, or plastic deformation shall occur, no safety hazard
Environmental	Operation Temperature	-25°C ~+80°C (see derating curve)
	Operation Humidity	10~ 90% RH (No Condensing) @ DC output with full load
	Storage Temperature	-10°C ~ +35°C
	Storage Humidity	<75%RH
Safety & EMC Requirement	Dielectric Strength	Primary to Secondary: 4000Vac 5mA, 3 sec .
	Radiation	Meeting EN55032, EN55014, FCC part 15, Class B.
	Conduction	Meeting EN55032, EN55014, FCC part 15, Class B.
	Safety Standards	Meet all requirements of : UL62368-1, CSA C22.2NO.62368-1-14, IEC/EN60335-1,IEC/EN61558-2-16, IEC/EN62368-1, CE,UKCA, Mark UL certificate NO.E345767 VDE certificate NO. 400xxxx
Reliability Requirement	MTBF	200K Hours Minimum @230VAC input, 50deg.C Calculated by MIL-HDBK-217-F2
	Burn-In Test	The unit shall be burned in for 2~ 5hours under 230Vac input and DC with full load at an ambient temperature of 30~45 degrees C
Mechanical	Physical Size	The units do not including PINs of input and output , and dimension is : (L)54.5*(W)28.5*(H)24.5± 0.5mm (see appearance drawing)
	Net Weight	Approximately 65 grams per product unit.
Guarantee	This product meets RoHS standard & REACH directives	

ONE OUTPUT 20W



MAIN FEATURES

- 20W Small Compact Size - PCB Mount
- Single Output
- Output Range : 3.3VDC - 24VDC
- Input Range: 85VAC - 265VAC/47 - 63Hz Or 120VDC - 370VDC
- Very Low Standby Power Consumption = 0.1W
- Better Energetic Efficiency: Meet Requirements Of Energy Star And EC Code Of Conduct
- Encapsulated Design
PCB Total Power Solution

- Safety: Complies with IEC/EN61558-2-16, IEC/EN62368-1, IEC/EN60335-1, UL62368-1, CSA C22.2NO.62368-1-14, CE.
- Materials: Uses UL 94-V0 Plastic And Resin
- EMC : Conducted And Radiated Emissions Conform To EN55032 ,FCCPart 15, CLASS B
- Immunity Conform To:
IEC/EN61000-3-2 CLASS A, EN61000-3-3, EN61000-4-2, IEC/EN61000-4-3,EN61000-4-4,EN61000-4-5, EN61000-4-6,EN61000-4-8,EN61000-4-11

Part Number	Output Power (W)	Output voltage (Vdc)	Output current (mA)	Output Load Regulation (%)	Max.Operating Ambient (°C)	Min. Part Efficiency (%)
47220	15	3.3	4500	± 4	50	82
47221	20	5	4000			
47222		9	2200			
47223		12	1700			
47224		15	1400			
47225		18	1100			
47226		24	840	± 3	60	85

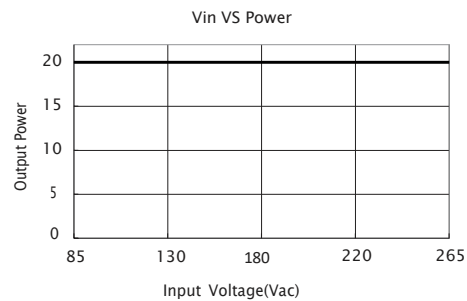
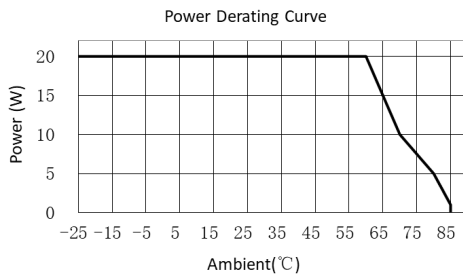

DIMENSIONS and PINOUT

4 pins
pins 1 & 5: AC or DC Input
pin 7 : DC output +V
pin 9 : DC output 0V

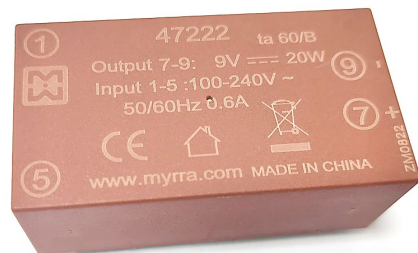
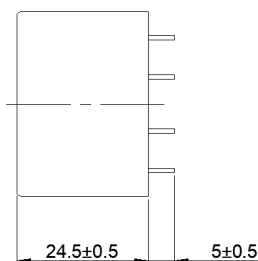
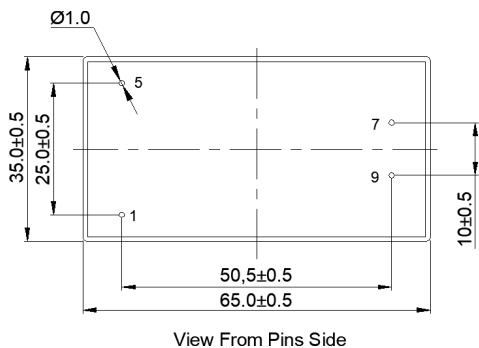

@ pending certification

Model: 20 Watt		Specification
AC Input Characteristics	Rated input Voltage	100~240Vac Or 140VDC-340VDC
	Input Voltage Range	85~265Vac Or 120VDC-370VDC
	AC Input Frequency	47Hz~63Hz
	Rated AC Input Frequency	50/60Hz
	Input Current	0.6A Max@85Vac~265Vac@DC output with full load
	Standby Power	0.15W Max (Meets requirements Of Energy Star And EC Code Of Conduct)
DC Output Characteristics	Output Voltage Accuracy	± 3% (9V, 12V, 15V, 18V, 24V Types) ± 4% (3.3V Type, 5V Type)
	Output Voltage Line Regulation	± 2% (9V, 12V, 15V, 18V, 24VTypes) ± 3% (3.3V and 5V Types)
	Output Voltage Load Regulation	± 3% (9V, 12V, 15V, 18V, 24V Types) ± 4% (3.3V Type, 5V Type)
	Ripple & Noise	Max 180mVp-p @Rated AC input (The measuring will be terminated with a 47uF AL E-Cap and a 0.1uF Cer-Cap. An oscilloscope set at 20MHz bandwidth)
	Efficiency	Meets requirements Of Energy Star And EC Code Of Conduct
Protection Characteristics	Over Current Protection	The power supply shall automatically protect. The power supply shall auto-recover normal operation after the deformation is removed. No excessive heat, odor, or plastic deformation shall occur, no safety hazard
	Output Short Circuit Protection	The power supply shall withstand a continuous output short without damage in 24 hours; The short may be applied before power on, or after power on; The power supply shall resume normal operation after the short is removed, no excessive heat, odor, or plastic deformation shall occur, no safety hazard
Environmental	Operation Temperature	-25°C ~+50°C (see derating curve)
	Operation Humidity	10~ 90% RH (No Condensing) @ DC output with full load
	Storage Temperature	-10°C~ +35°C
	Storage Humidity	<75%RH
Safety & EMC Requirement	Dielectric Strength	Primary to Secondary: 4000Vac 5mA, 3 sec .
	Radiation	Meeting EN55032, FCC part 15, Class B
	Conduction	Meeting EN55032, FCC part 15, Class B
	Safety Standards	Meet all requirements of : UL62368-1, CSA C22.2NO.62368-1-14, IEC/EN60335-1, IEC/EN61558-2-16, IEC/EN62368-1
Reliability Requirement	MTBF	Calculated by MIL-HDBK-217-F2 200K Hours Minimum @230VAC input, 50deg.C
	Burn-In Test	The unit shall be burned in for 2~ 5hours under 230Vac input and DC with full load at an ambient temperature of 30~45 degrees C
Mechanical	Physical Size	The units do not including PINs of input and output , and dimension is : (L)65*(W)35*(H)24.5± 0.5mm (see appearance drawing)
	Net Weight	Approximately 92 grams per product unit.
Guarantee	This product meets RoHS standard	

ONE OUTPUT 60W



MAIN FEATURES

- Small Compact Size - PCB Mount
- Single Output
- Output Range : 5VDC - 24VDC
- Input Range: 85VAC - 265VAC/47 - 63Hz Or 120VDC - 370VDC
- Very Low Standby Power Consumption= 0.1W
- Better Energetic Efficiency: Meet Requirements Of Energy Star And EC Code Of Conduct
- Encapsulated Design PCB Total Power Solution

- Safety: Complies with IEC/EN61558-2-16, IEC/EN62368-1, IEC/EN60335-1, UL62368-1, CSA C22.2NO.62368-1-14, CE.
- Materials: Uses UL 94-V0 Plastic And Resin
- EMC : Conducted And Radiated Emissions Conform To EN55032,FCC Part15 CLASS B
- Immunity Conform To: IEC/EN61000-3-2 CLASS A, EN61000-3-3, EN61000-4-2, IEC/EN61000-4-3, EN61000-4-4,EN61000-4-5,EN61000-4-6, EN61000-4-8 EN61000-4-11

Part Number	Output Power (W)	Output Voltage (Vdc)	Output Current (mA)	Output Load Regulation (%)	Max.Operating Ambient (°C)	Min. Part Efficiency (%)
47261	50	5	10000	± 5	50	82
47262	60	9	6600	± 3		85
47263		12	5000			
47264		15	4000			
47265		18	3300			
47266		24	2500			

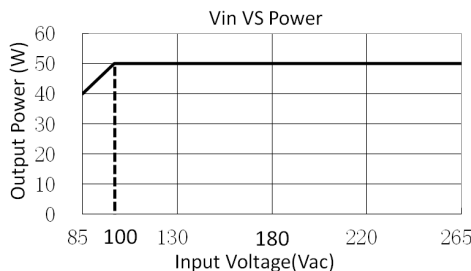
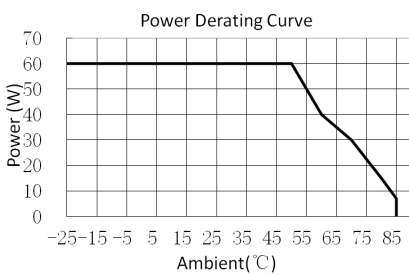

DIMENSIONS and PINOUT

4 pins
pins 1 & 5: AC or DC Input
pin 7 : DC output +V
pin 9 : DC output 0V

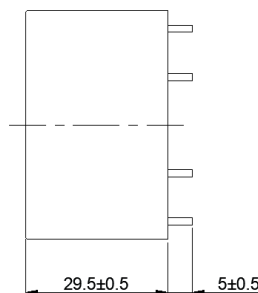
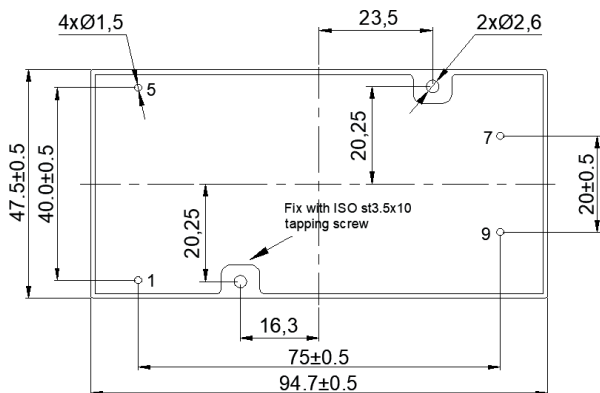

@ pending certification

Model: 60 Watt		Specification
AC Input Characteristics	Rated input Voltage	100~240Vac Or 140VDC-340VDC
	Input Voltage Range	85~265Vac Or 120VDC-370VDC
	AC Input Frequency Range	47Hz~63Hz
	Rated AC Input Frequency	50/60Hz
	Input Current	1.5A Max@85Vac~265Vac@DC output with full load
	Standby Power	0.15W Max (Meet Requirements Of Energy Star And EC Code Of Conduct)
DC Output Characteristics	Output Voltage Accuracy	± 3% (9V, 12V, 15V, 18V, 24V Types) ± 5% (5V Type)
	Output Voltage Line Regulation	± 3% (9V, 12V, 15V, 18V, 24V Types) ± 5% (5V Types)
	Output Voltage Load Regulation	± 3%(9V,12V,15V,18V,24V Types) ± 5% (5V Type)
	Ripple & Noise	Max 200mVp-p @Rated AC input (The measuring will be terminated with a 47uF AL E-Cap and a 0.1uF Cer-Cap. An oscilloscope set at 20MHz bandwidth)
	Efficiency	See table (Meet Requirements Of Energy Star And EC Code Of Conduct)
Protection Characteristics	Over Current Protection	The power supply shall automatic protection. The power supply shall auto-recovery normal operation after the deformation is removed. No excessive heat, odor, or plastic deformation shall occur, no safety hazard
	Output Short Circuit Protection	The power supply shall withstand a continuous output short without damage in 24 hours ; The short may be applied before power on, or after power on; The power supply shall resume normal operation after the short is removed, no excessive heat, odor, or plastic deformation shall occur, no safety hazard
Environmental	Operation Temperature	-25°C ~ + 50°C (see derating curve)
	Operation Humidity	10~ 90% RH (No Condensing) @ DC output with full load
	Storage Temperature	-10°C~ +35°C
	Storage Humidity	<75%RH
Safety & EMC Requirement	Dielectric Strength	Primary to Secondary : 4000Vac 5mA, 3 sec.
	Radiation	Meeting EN55032, FCC part 15, Class B
	Conduction	Meeting EN55032, FCC part 15, Class B
	Safety Standards	Meet all requirements of : UL62368-1, CSA C22.2NO.62368-1-14, IEC/EN60335-1, IEC/EN61558-2-16, IEC/EN62368-1
Reliability Requirement	MTBF	Calculated by MIL-HDBK-217-F2 200K Hours minimum @230VAC input, 50deg.C
	Burn-In Test	The unit shall be burned in for 2~ 5hours under 230Vac input and DC with full load at an ambient temperature of 30~45 degrees C
	Net Weight	Approximately 245 grams per product unit.
Guarantee	This product meet to RoHS standard	

Myrra reserve the right to change specifications in this document without notice

65W LED Driver



MAIN FEATURES

- 65W Small Compact Size- Metal housing design
- Constant Current Mode Output
- Built-in active PFC Function:>0.95
- Output Range : 6VDC - 48VDC
- Input Range: 100VAC - 305VAC/47- 63Hz
- Very Low Standby Power Consumption<0.5W
- IP65 Rating For Indoor Or Outdoor Installations
- 3 In 1 Dimming(1V to 10Vdc or 10V PWM Signal or resistance)
- Safety: Complies with IEC/EN61347-1, IEC/EN61347-2-13, UL8750 CALSS 2, CSA C22.2NO.250.13-12,CE,UKCA,IP65
- Materials: Uses UL 94-V0 Resin
- EMC : Conducted And Radiated Emission conform To EN55015,FCC Part 15, CLASS B, IEC/EN61000-3-2 CLASS C, EN61000-3-3 without any additional components.
- Immunity Conform To:EN61000-4-2, IEC/EN61000-4-3, EN61000-4-4,EN61000-4-5,EN61000-4-6, EN61000-4-8 EN61000-4-11

Part Number	Output Power (W)	Output Voltage (Vdc)	Output Current (mA)	Input Range	Max.Operating Ambient (°C)	Min. Part Efficiency (%)
49120K	48	6.0 ~12	4000	100Vac – 305Vac	-25°C ~ +70°C	>86%
49240K	65	12 ~24	2700			>88%
49360K		21.5 ~36	1800			>89%
49420K		25 ~42	1550			>90%
49480K		32 ~48	1350			

DERATING GRAPH

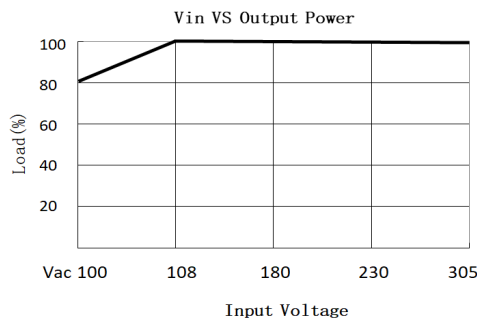
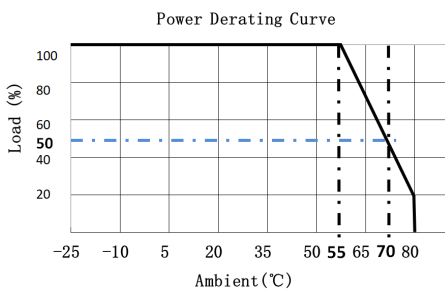

DIMMING GRAPH

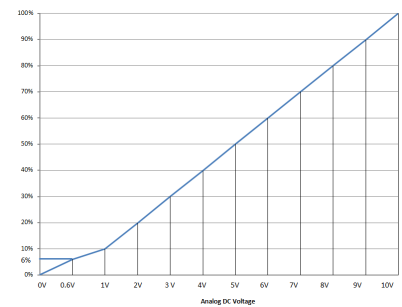

DIMENSIONS

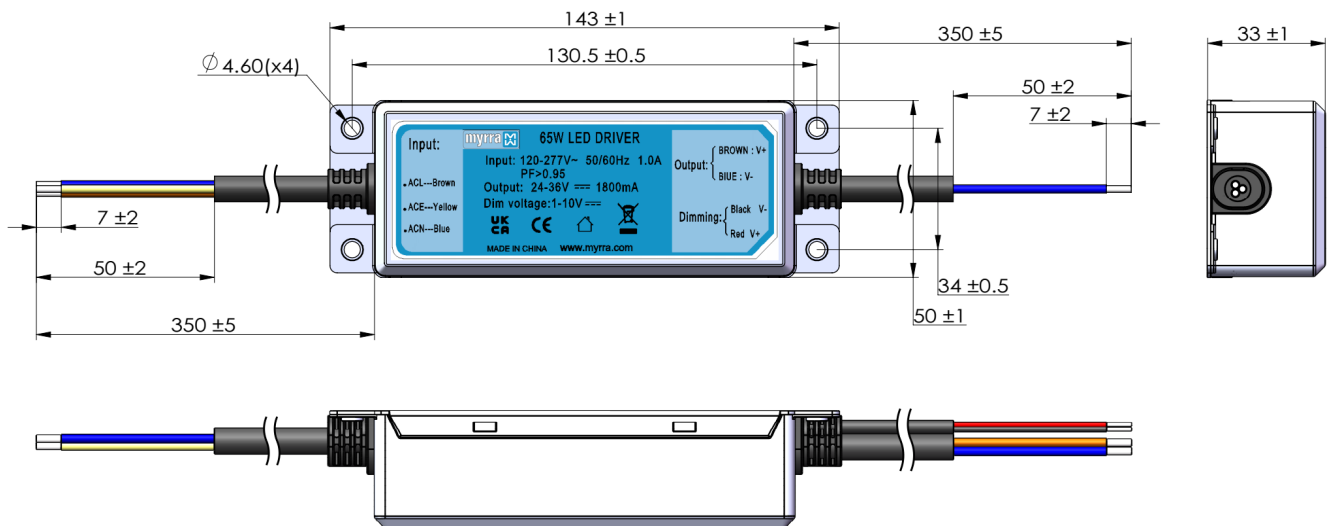

Model: 65 Watt		Specification
AC Input Characteristics	Rated input Voltage	120~277Vac
	Input Voltage Range	100~305Vac
	AC Input Frequency Range	47Hz~63Hz
	Rated AC Input Frequency	50/60Hz
	Input Current	1.0A Max@108Vac~305Vac@DC output with full load
	Standby Power	0.5W Max (Meet Requirements Of Energy Star And EC Code Of Conduct)
	Total Harmonic Distortion	≤20% @output load≥75%
	Leakage Current	<0.75mA@277Vac
	Max.No.of PSU on 16A circuit breaker	26 units(circuit breaker of type B)/26 units(circuit breaker of type C)at 230VAC.
DC Output Characteristics	Output Voltage Range	See table
	Output Voltage Line Regulation	± 5%
	Output Voltage Load Regulation	± 5%
	Ripple & Noise	Max 10%Ip-p@ 120Vac ~277Vac (The measuring will be terminated with a 47uF AL E-Cap and a 0.1uF Cer-Cap. An oscilloscope set at 20MHz bandwidth).
	Efficiency	See table (Meet Requirements Of Energy Star And EC Code Of Conduct)
Protection Characteristics	Over Voltage Protection	The LED driver shall automatic protection(hiccup mode). The LED driver shall auto-recovery normal operation after the deformation is removed. No excessive heat, odour, or plastic deformation shall occur, no safety hazard.
	Output Short Circuit Protection	The power supply shall withstand a continuous output short without damage in 24 hours ; The short may be applied before power on, or after power on; The power supply shall resume normal operation after the short is removed, no excessive heat, odour, or plastic deformation shall occur, no safety hazard
	Over Temperature Protection	Hiccup mode, recovers automatically after fault condition is removed.
Environmental	Operation Temperature	-25°C ~ + 70°C (Refer to "Derating Graph")
	Operation Humidity	10~ 90% RH (No Condensing) @ DC output with full load
	Storage Temperature	-10°C~ +35°C
	Storage Humidity	<75%RH
Safety & EMC Requirement	Dielectric Strength	Input to Output 3kVAC,5mA,1 min(3.75kVAC,3s @at the mass production stage) Input to Ground 1.5kVAC, 5mA,1 min Output to Ground 500VAC ,5mA,1 min
	Radiation	Meeting EN55015, FCC part 15, Class B
	Conduction	Meeting EN55015, FCC part 15, Class B
	Safety Standards	Meet all requirements of : IP65; UL8750 CLASS2; CSA C22.2NO.250.13-12;IEC/EN61347-1;IEC/EN61347-2-13; CE, UKCA Mark
Reliability Requirement	MTBF	>200K Hours @230VAC input at max operation temperature; >550K Hours @230VAC input at 25deg.C Calculated in accordance with MIL-HDBK-217-F2
	Burn-In Test	The unit shall be burned in for 2~ 5hours under 230Vac input and DC with full load at an ambient temperature of 30~45 degrees C
	Net Weight	Approximately 450 grams per product unit.
Guarantee	This product meet to RoHS standard	

100W Industrial Power Supply



MAIN FEATURES

- 100W Small Compact Size
- Built-in active PFC Function:>0.92
- Output Range : 3.3VDC - 48VDC
- Input Range: 85VAC - 305VAC/47- 63Hz
- Very Low Standby Power Consumption<0.3W
- Safety: Complies with IEC/EN62368-1, IEC/EN60335-1, IEC/EN61558-2-16, UL62368-1, CSA C22.2NO.62368-1-14,CE,UKCA
- EMC : Conducted And Radiated Emission conform To EN55032,FCC Part 15, CLASS B, IEC/EN61000-3-2 CLASS C, EN61000-3-3 without any additional components.
- Immunity Conform To:EN61000-4-2, IEC/EN61000-4-3, EN61000-4-4,EN61000-4-5,EN61000-4-6, EN61000-4-8, EN61000-4-11

Part Number	Output Power (W)	Output Voltage (Vdc)	Output Current (A)	Input Range	Operating Ambient (°C)	Min. Part Efficiency (%)
49033N	66	3.3	20	85Vac – 305Vac (120Vdc – 430Vdc)	-25°C ~ +70°C	>75%
49050N	90	5.0	18			>87%
49120N	102	12	8.5			>90%
49150N	105	15	7.0			>90%
49240N	108	24	4.5			>90%
49360N	108	36	2.8			>90%
49480N	110	48	2.3			>90%

DERATING GRAPH

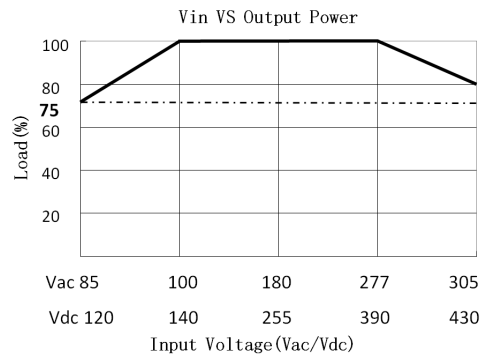
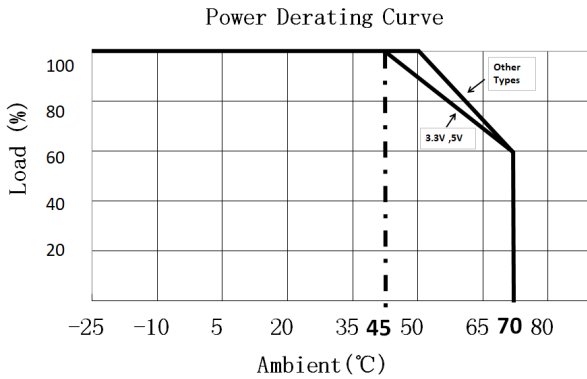

DIMENSIONS

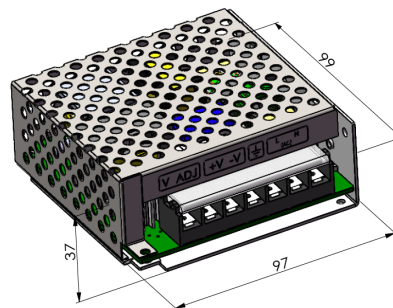
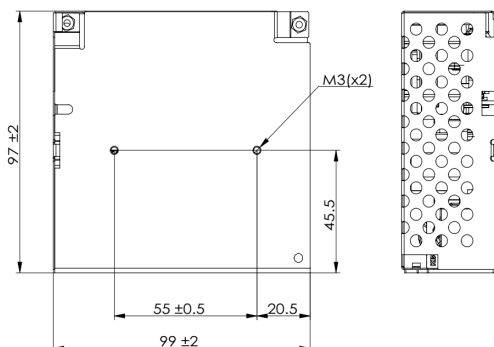
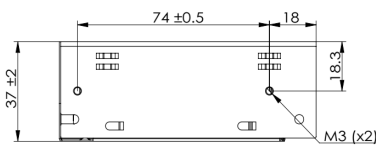

Model: 100 Watt		Specification
AC Input Characteristics	Rated input Voltage	100~277Vac
	Input Voltage Range	85~305Vac
	AC Input Frequency Range	47Hz~63Hz
	Rated AC Input Frequency	50/60Hz
	Input Current	2.0A Max@85Vac~305Vac@DC output with full load
	Standby Power	0.3W Max (Meet Requirements Of Energy Star And EC Code Of Conduct)
	Leakage Current	<0.75mA@305Vac
DC Output Characteristics	Output Voltage Range - ADJ	Refer to P/N specification
	Output Voltage Accuracy	± 2%
	Output Voltage Line Regulation	± 0.5%
	Output Voltage Load Regulation	± 1%
	Ripple & Noise	Max 180mVp-p@ Rated AC input, at nominal line (The measuring will be terminated with a 47µF AL E-Cap and a 0.1µF Ceramic-Cap. An oscilloscope set at 20MHz bandwidth)
	Dynamic Response	The output voltage shall not exceed ± 10% rated output voltage @ 50% <--> 100 % Load change, 1A/µS, 1KHz 50% duty cycle.
	Efficiency	See table (Meet Requirements Of Energy Star And EC Code Of Conduct)
Protection Characteristics	Over Current Protection	The power supply shall automatic protection. The power supply shall auto-recovery normal operations after the deformation is removed. No excessive heat, odour, or plastic deformation shall occur with no safety hazard
	Output Short Circuit Protection	The power supply shall withstand a continuous output short without damage in 24 hours ; The short may be applied before power on, or after power on; The power supply shall resume normal operation after the short is removed, no excessive heat, odour, or plastic deformation shall occur, no safety hazard
	Over Temperature Protection	Hiccup mode, recovers automatically after fault condition is removed.
Environmental	Operation Temperature	-25°C ~ + 70°C (Refer to "Derating Graph")
	Operation Humidity	10~ 90% RH (No Condensing) @ DC output with full load
	Storage Temperature	-10°C~ +35°C
	Storage Humidity	<75%RH
Safety & EMC Requirement	Dielectric Strength	Input to Output 4kVAC,5mA,1 min Input to Ground 2kVAC,10mA,1 min Output to Ground 1.25kVAC ,10mA,1 min
	Radiation	Meeting EN55032, FCC part 15, Class B
	Conduction	Meeting EN55032, FCC part 15, Class B
	Safety Standards	Meet all requirements of : UL62368-1,CSA C22.2 NO.62368-1-14, IEC/EN62368-1,IEC/EN60335-1,IEC/EN61558-2-16 CE, UKCA Mark
Reliability Requirement	MTBF	>200K Hours @230VAC input at max operation temperature; >550K Hours @230VAC input at 25deg.C Calculated in accordance with MIL-HDBK-217-F2
	Burn-In Test	The unit shall be burned in for 2~ 5hours under 230Vac input and DC with full load at an ambient temperature of 30~45 degrees C
	Net Weight	Approximately 260 grams per product unit.
Guarantee	This product meet to RoHS standard	

Application notes



1 – Storage Guide:

Encapsulated type product:

Storage temperature: -10°C to +35°C, Storage humidity: <75%RH

Non-encapsulated type product:

Storage temperature: +5°C to +35°C, Storage humidity: <75%RH

2 – Shelf life Guide :

Encapsulated type product:

To ensure best power supply reliability and life, the customer shall limit the power supply shelf life to no longer than 6 months after delivery. The maximum recommended period before the power supply shall be powered is 18 months from the power supply date code.

Non-encapsulated type product:

To ensure best power supply reliability and life, the customer shall limit the power supply shelf life to no longer than 6 months after delivery. The maximum recommended period before the power supply shall be powered is 12 months from the power supply date code.

3 –General Storage Conditions:

MYRRA power supplies should be stored in their original packaging before use. In the warehouse, there should not be harmful gas, inflammable, explosive products, corrosive chemical products, strong mechanical vibration, shock and strong magnetic field effects. The package box should be stored above ground by at least 20cm height, and 50cm away from any wall, thermal source, and vent.

4- Safety and recommend wiring : linewidth A≥2mm, B≥5mm.

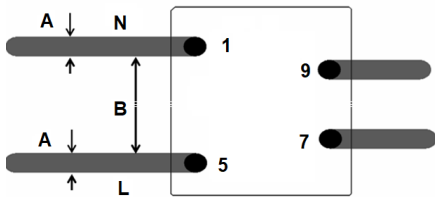

5- Recommended circuit for applications requiring higher EMC performance :

The 47/48 series are already certified as compliant to EN55022 and EN55014 CLASS B for emc. For this compliance no additional external components are required. Should a more stringent emc performance be required the circuit below can be proposed

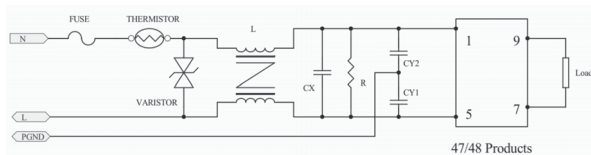

Fuse: recommended parameters : 5A to 10A/250Vac, Time-lag type.
THERMISTOR: recommended parameters : 2A, 5Ω, 1.8W to 5A D10, 2.5Ω, 2.4W.
Varistor: recommended parameters : 14D471, 300Vac, maximum energy 118 Joule.
L is a common mode inductor : recommended parameters : 10mH to 30mH
CX is a X2 capacitor : recommended parameters : 0.1uF to 0.22uF/275Vac
CY1 and CY2 are Y capacitors : recommended parameters : 1000pF to 2200pF/400V
R is a resistor : recommended parameters: 1.0MΩ to 3.0 MΩ.

6 – Application of the connection to ground :

This application is not supported for by Myrra SMPS products

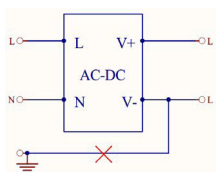

The following proposed circuit may assist :

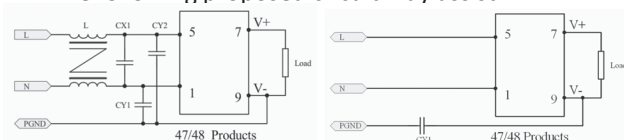

L : is a common mode inductor, the recommended parameters: 10mH to 30mH
CX1 : is an X2 capacitor, the recommended parameters : 0.1uF to 0.22uF/275Vac
CY1 and CY2 are Y capacitors, the recommended parameters : 1000pF to 2200pF/400V

7 – High surge circuit :

The 47 / 48 Series is tested and certified for a surge level in accordance with IEC61000-4-5 as standard without requiring any additional external components. To extend the surge level to 6KV the external circuit below can be proposed.

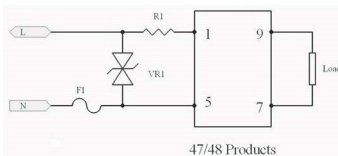

VR1 is a varistor, the recommended parameters : 14D471, 300Vac, maximum energy 118 Joule.

R1 is a wire-wound resistor, the recommended parameters : 10R/1W to 10R/3W, resistance wire $\Phi 0.1$ to 0.23mm. F1 is a fuse, the recommended parameters : 6.3A to 10A/250Vac, Time-lag type.

The information contained in this document is subject to change without notice.

Modified and Custom Solutions

TECHNICAL SERVICES :

- Alternative DC Output Voltages
- Single, Dual or Triple Output Voltages
- Addition of Signal Pins for AC OK, Remote on/off, sense etc.
- Alternative Power Rating
- Revised 'Hold-up' timing to suit System needs
- Customer specific product 'Branding/Labeling'
- Specific Power Supply Manufacturing Functional Test Profile
- Integrating the Power Supply on the System PCB
- Alternative Power Supply Housing
- Revised DC Output Filtering

CUSTOMER SERVICES :

- Existing Designs for Modified Standards
- Flexible Manufacturing Batch Sizes
- European Stock-holding locations
- European Engineering and Logistics Support
- Country Specific Distribution Partners
- Manufacturing dynamics for Volume Fluctuations
- Myrra Quality Controlled Design and Manufacturing
- Fast Sample Service

Contact us for your Power needs at : contact@myrra.com





Power Supplies

A Reliable Brand for your application

www.myrra.com

www.myrra-powersupplies.com